



EXPERIENCE

HAND MADE IN ITALY SINCE 1990

SOFT LIVING



EXPERIENCE

HAND MADE IN ITALY SINCE 1990

SOFTLIVING

Il trendy quotidiano

Da Felis... un nuovo insieme di collezioni.
Un progetto di gusto altoborghese, elegante,
di personalità forte, di carattere... Ma senza esibizioni.
Interessanti possibilità progettuali per spazi privati
come per grandi soluzioni contract.
Per il design di ambienti living, a misura delle diverse
individualità e del diverso sentire di ognuno.
Per definire gli spazi e lo stile del nostro quotidiano
abitare nel modo più confortevole...
Per dare la giusta atmosfera oltre la dittatura delle mode.

The daily trendy

From Felis... a new set of collections.
An upper-class taste project, elegant,
with strong personality and character...
But without exhibitionism. Interesting design
possibilities for private spaces and large
contract solutions. To design living environments,
tailored to different individuals with different taste.
To define the space and the style of
our daily living in the most comfortable way...
To create the right atmosphere beyond fashion.

Le branché au quotidien

Chez Felis... une nouvelle série de collections.
Un projet au goût bourgeois, élégant, avec
une forte personnalité et du caractère... Mais sans
s'imposer. D'intéressantes possibilités conceptuelles
pour des espaces privés ou pour le contract.
Pour la conception d'espaces de vie,
adaptés à chaque individualité et aux différentes sensations
de chacun. Pour définir l'espace et le style de notre
vie quotidienne de la façon la plus confortable...
our la juste atmosphère au-delà du dictat des modes.

Summary



4 | **KENDAL**



32 | **AJAR**



68 | **ANGEL**



98 | **NEWMAN**



18 | **KLOÈ**



50 | **WINSTON**



88 | **ASPEN**



118 | **PAUL**



128 | **FLAMINGO**
collection



132 | **PILLS**
collection



138 | **ZEPPELIN**



142 | **FUJI**



Kendal

Un contemporaneo classico. Linee essenziali, sostegni leggeri, funzionale, ma accogliente e morbido.

A contemporary classic.
Clean lines, light supports,
functional, but warm and soft.

Un contemporain classique.
Des lignes minimalistes,
des supports légers,
un style fonctionnel,
mais accueillant et moelleux.





Kendal



Kendal



**Divani diversi,
poltrona e
grandi pouf per
un programma living
ricco e completo.**

Several sofas,
an armchair and
a large ottoman for a
rich and comprehensive
living program.

Des canapés différents,
un fauteuil et de grands
poufs pour une solution
riche et complète.

Kendal





Kendal

La pulizia formale e la apparente semplicità come scelta di identità e di stile.

The clean lines and the apparent simplicity as a choice of identity and style.

Une netteté formelle et une apparente simplicité comme choix d'identité et de style.



Kendal

Kendal

Completamente sfoderabile
Totally removable cover
Complètement déhoussable



Caratteristiche tecniche

Struttura - Realizzata con masselli portanti in legno massiccio di abete in vari spessori. Fianchi e parti strutturali in multistrato di abete da 18 mm, parti di tamponamento in agglomerato di legno di spessore 18mm e 4 mm. Il tutto trattato al naturale in classe E1, pertanto a bassa emissione di formaldeide. Il telaio è completamente rivestito con vellutino 100% poliammine termo accoppiato ad espanso 100% polietere e/o ovatta resinato da 200 gr di 100% poliestere.

Imbottitura - Cuscino seduta in poliuretano espanso flessibile e indeformabile in densità D35 SR rivestito in falda termolegata da 300 gr in poliestere 100%. Cuscino schiena in poliuretano espanso flessibile e indeformabile in densità D18 morbido, rivestito in falda termolegata da 300 gr in 100% poliestere. Tamponi in espanso indeformabile D21.DPK40, bracciolo in D30 indeformabile rivestito in resinato da 200 gr in 100% poliestere. **I materiali corrispondono alle normative europee 91/156/ etc. Informazioni ambientali sulla sicurezza:** la deperibilità del prodotto, secondo la sua composizione, è praticamente nulla. Le resine non sono contenute nella lista della normativa di classificazione dei rifiuti per materiali soggetti a particolare sorveglianza. Le resine espanso sono esenti da freon e solventi clorurati. Le resine espanso non contengono sostanze che danneggiano l'ozonofera e non vengono fabbricate con prodotti menzionati nel protocollo di Montreal e Regolamento (CE) n. 3093/94.

Poggiatesta a cilindro e a cuscinetto totalmente rivestiti in tessuto.

Piedini ed accessori - Piedini in metallo, di forme diverse, verniciati con polveri epossidiche e cromati.

Molleggio - Il molleggio è realizzato in nastri da 80 mm tesi meccanicamente, composta da fili di nylon avvolto a spirale.

Technical characteristics

Structure - Made with bearing parts in solid fir wood in various thicknesses. 18mm fir plywood sides and structural parts, 18mm and 4 mm thick particle wood infill parts. All treated naturally in Class E1, thus with low formaldehyde emissions. The frame is completely covered with 100% polyamines velveteen thermo-coupled with 100% polyether foam and/or 100% polyester 200 g. wadding resin.

Paddin - Flexible and non-deformable polyurethane foam seat cushion, density D35 SR, coated with 300 gr layer-bonded 100% polyester. Flexible and non-deformable polyurethane foam back cushion, density D35 SR, coated with 300 gr layer-bonded 100% polyester. Non-deformable polyurethane foam pads, D21, DPK40; non-deformable armrest, D30, coated with 200 gr layer-bonded 100% polyester. **The materials meet the European standards 91/156/etc. Environmental information on safety:** The perishable nature of the product, according to its composition, is practically nil. Resins are not included in the list of standards for the classification of waste materials subject to special surveillance. Resin foams are free from freon and chlorinated solvents. Resin foams do not contain substances that damage the ozone layer and are not manufactured with products mentioned in the Montreal Protocol and (CE) Regulation no. 3093/94.

Cylinder and pad headrest completely coated with fabric.

Feet and accessories - Metal feet of different shapes, epoxy coated and chrome.

Springing - The springing is made of 80 mm mechanically stretched strips, composed of nylon wires wound in a spiral.

Caractéristiques techniques

Structure - Réalisée avec des éléments porteurs en bois massif de sapin de différentes épaisseurs. Panneaux latéraux et éléments structuraux en bois de sapin stratifié de 18 mm, élément de remplissage en agglomérat de bois de 18 mm et 4 mm. Le tout traité au naturel en classe E1, soit à faible émission de formaldéhydes. Le cadre est entièrement recouvert de velours 100% polyamines couplé à chaud avec de la résine expansée 100% polyéther et/ou ouate de 200 g 100% polyester.

Rembourrage - Coussin d'assise en mousse de polyuréthane souple et indéformable densité D35 SR revêtu en couche collée de 300 g 100% polyester. Coussin de dossier en mousse de polyuréthane souple et indéformable densité D18 moelleux, revêtu en couche collée de 300 g 100% polyester. Éléments de remplissages en mousse indéformable D21, DPK40, accoudoir en D30 indéformable revêtu de résine 200 g 100% polyester. **Les matériaux sont conformes aux normes européennes 91/156/etc Informations environnementales sur la sécurité:** la nature périssable du produit, sur la base de sa composition, est pratiquement nulle. Les résines ne figurent pas dans la liste établie par la norme de classification des déchets de matériaux soumis à une surveillance particulière. Les résines expansées ne contiennent pas de fréon ni de solvants chlorés. Les résines expansées ne contiennent pas de substances nuisibles à la couche d'ozone et ne sont pas fabriquées avec des produits figurant dans le Protocole de Montréal et le Règlement (CE) n° 3093/94. **Appuie-tête cylindrique et coussin** entièrement recouvert de tissu.

Pieds et accessoires - Pieds en métal, de différentes formes, peints avec peinture époxy et chromés.

Suspension - La suspension est réalisée avec des bandes de 80 mm tendues mécaniquement, composées de fils de nylon enroulés en spirale.

Elementi fissi / Fixed units / Éléments fixes

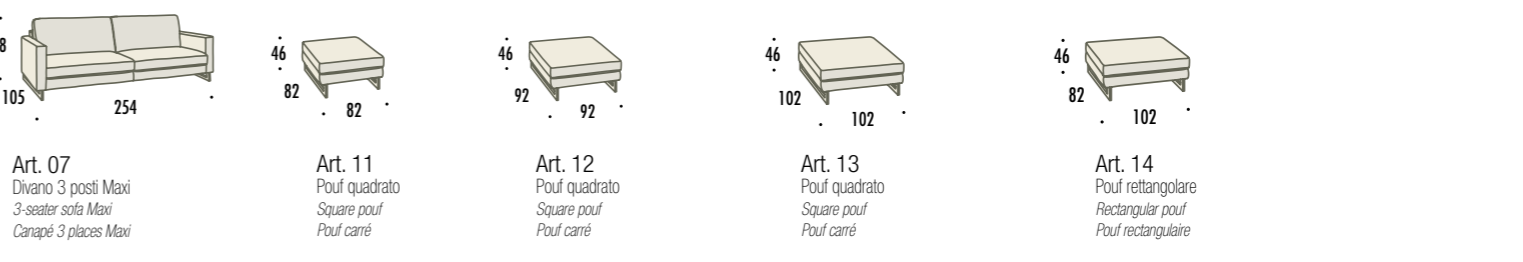
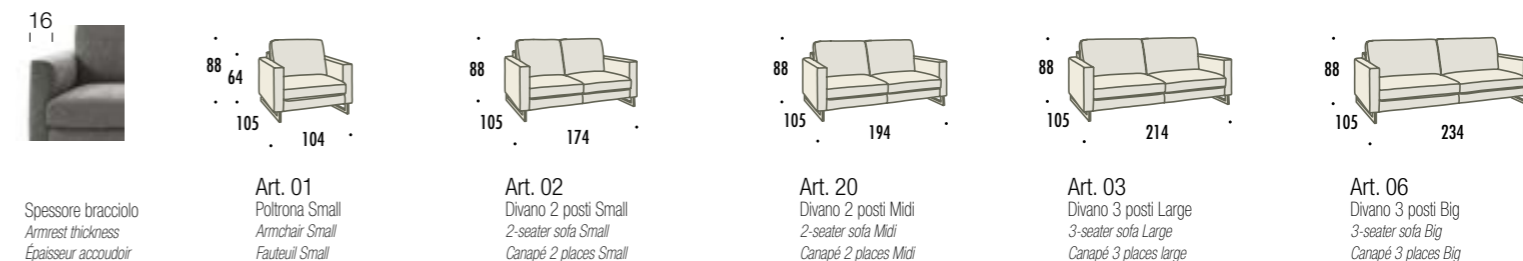

Elementi componibili / Modular units / Éléments composites

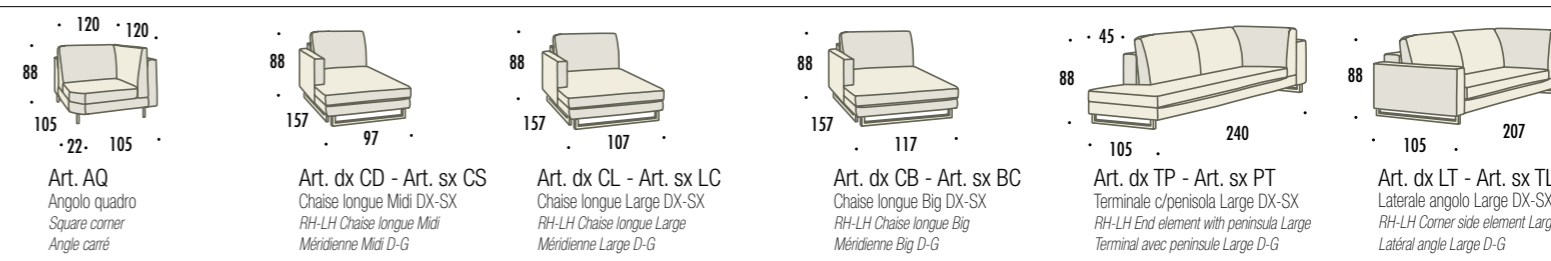
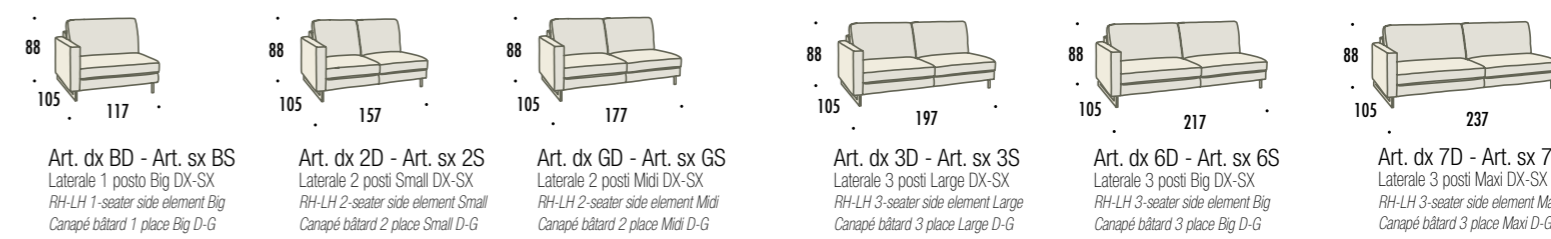
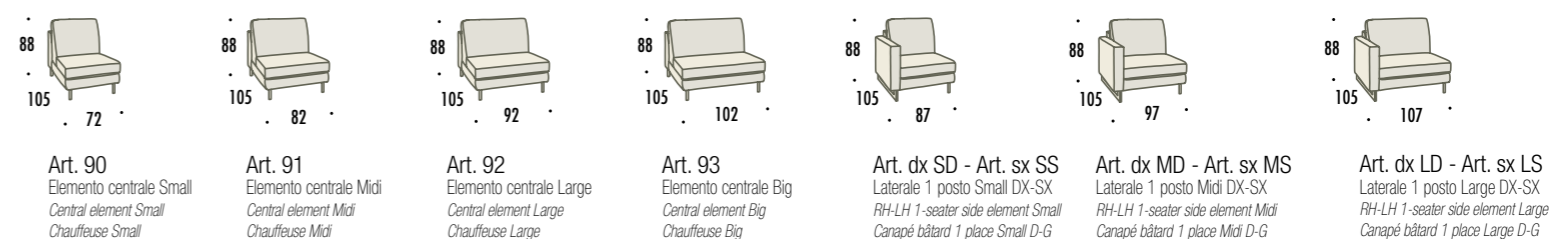

Piede TWINNY a doppio stiletto H. 14 / Double stiletto TWINNY foot H. 14 / Pied TWINNY double talon H. 14



Barra ICE H.14 / ICE bar H.14 / Barre ICE H.14



Optional poggiatesta / Optional headrest / Option appuie-tête



Esempio composizione / Layout example / Exemple de composition

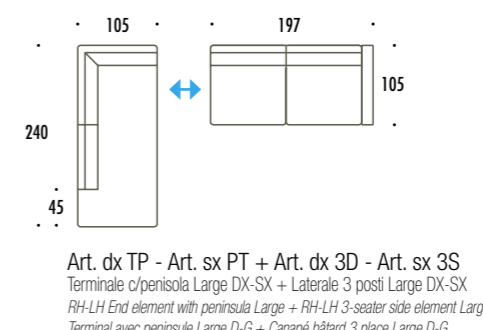
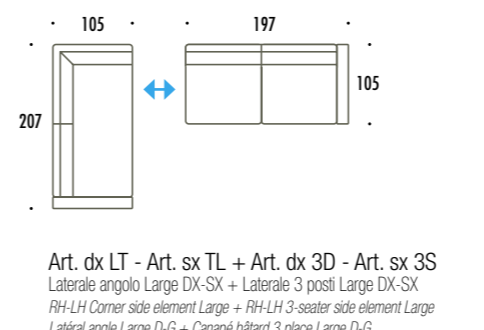



Kloè

Il particolare sartoriale e prezioso del cordoncino, in tinta o a contrasto. Disegna il profilo della struttura e la forma intera di sedute e schienali. Design essenziale e finiture dai toni carbon look.

The special and precious tailoring detail of the lanyard, matching or contrasting. Draw the profile the structure and the whole shape of seats and backrests. Essential design and finishes with carbon look tones.

Le cousu particulier et précieux du passepoil, ton sur ton ou en contraste, dessine la forme de la structure et celle de l'intégralité de l'assise et des dossiers. Un design minimaliste et des finitions aux tons «carbon look».





Kloè



**Potere della semplicità sofisticata.
Sedute e schienali ampi ma sostenuti.
Braccioli contenuti.
Un design d'insieme essenziale, per un comfort contemporaneo.**

Power of sophisticated simplicity.
Seats and backrests, large but firm.
Contained armrests. An essential design for contemporary comfort

Le pouvoir de la simplicité sophistiquée.
Des assises et des dossiers larges mais soutenus.
Des accoudoirs contenus.
Un dessin d'ensemble minimaliste, pour un confort contemporain.





Kloè



Kloè



**I profili accompagnano
le forme.**

The profiles accompany the
shapes.

Les passepoils accompagnent
les formes.

Kloè



Kloè

Completamente sfoderabile
Totally removable cover
Complètement déhoussable



Caratteristiche tecniche

Struttura - Realizzata con masselli portanti in legno massiccio di abete in vari spessori. Fianchi e parti strutturali in multistrato di abete da 18 mm, parti di tamponamento in agglomerato di legno di spessore 18mm e 4 mm. Il tutto trattato al naturale in classe E1, pertanto a bassa emissione di formaldeide. Il telaio è completamente rivestito con vellutino 100% poliammine termo accoppiato ad espanso 100% polietere e/o ovatta resinato da 200 gr di 100% poliestere.

Imbottitura - Cuscino seduta in poliuretano espanso flessibile e indeformabile in densità D35 SR rivestito in falda termolegata da 300 gr in poliestere 100%. Cuscino schiena in poliuretano espanso flessibile e indeformabile in densità D18 morbido, rivestito in falda termolegata da 300 gr in 100% poliestere. Tamponi in espanso indeformabile D21.DPK40, bracciolo in D30 indeformabile rivestito in resinato da 200 gr in 100% poliestere. **I materiali corrispondono alle normative europee 91/156/ etc Informazioni ambientali sulla sicurezza:** la deperibilità del prodotto, secondo la sua composizione, è praticamente nulla. Le resine non sono contenute nella lista della normativa di classificazione dei rifiuti per materiali soggetti a particolare sorveglianza. Le resine espanso sono esenti da freon e solventi clorurati. Le resine espanso non contengono sostanze che danneggiano l'ozonofera e non vengono fabbricate con prodotti menzionati nel protocollo di Montreal e Regolamento (CE) n. 3093/94.

Poggiatesta a cilindro e a cuscinetto totalmente rivestiti in tessuto.

Piedini ed accessori - Piedini in metallo, di forme diverse, verniciati con polveri epossidiche e cromati.

Molleggio - Il molleggio è realizzato in nastri da 80 mm tesi meccanicamente, composta da fili di nylon avvolto a spirale.

Technical characteristics

Structure - Made with bearing parts in solid fir wood in various thicknesses. 18mm fir plywood sides and structural parts, 18mm and 4 mm thick particle wood infill parts. All treated naturally in Class E1, thus with low formaldehyde emissions The frame is completely covered with 100% polyamines velveteen thermocoupled with 100% polyether foam and/or 100% polyester 200 g. wadding resin.

Padding - Flexible and non-deformable polyurethane foam seat cushion, density D35 SR, coated with 300 gr layer-bonded 100% polyester Flexible and non-deformable polyurethane foam back cushion, density D35 SR, coated with 300 gr layer-bonded 100% polyester Non-deformable polyurethane foam pads, D21, DPK40; non-deformable armrest, D30, coated with 200 gr layer-bonded 100% polyester. **The materials meet the European standards 91/156/etc. Environmental information on safety:** The perishable nature of the product, according to its composition, is practically nil. Resins are not included in the list of standards for the classification of waste materials subject to special surveillance. Resin foams are free from freon and chlorinated solvents. Resin foams do not contain substances that damage the ozone layer and are not manufactured with products mentioned in the Montreal Protocol and (CE) Regulation no. 3093/94.

Cylinder and pad headrest completely coated with fabric.

Feet and accessories - Metal feet of different shapes, epoxy coated and chrome.

Springing - The springing is made of 80 mm mechanically stretched strips, composed of nylon wires wound in a spiral.

Caractéristiques techniques

Structure - Réalisée avec des éléments porteurs en bois massif de sapin de différentes épaisseurs. Panneaux latéraux et éléments structuraux en bois de sapin stratifié de 18 mm, élément de remplissage en agglomérat de bois de 18 mm et 4 mm. Le tout traité au naturel en classe E1, soit à faible émission de formaldéhydes. Le cadre est entièrement recouvert de velours 100% polyamines couplé à chaud avec de la résine expansée 100% polyéther et/ou ouate de 200 g 100% polyester.

Rembourrage - Coussin d'assise en mousse de polyuréthane souple et indéformable densité D35 SR revêtu en couche collée de 300 g 100% polyester. Coussin de dossier en mousse de polyuréthane souple et indéformable densité D18 moelleux, revêtu en couche collée de 300 g 100% polyester Éléments de remplissages en mousse indéformable D21, DPK40, accoudoir en D30 indéformable revêtu de résine 200 g 100% polyester. **Les matériaux sont conformes aux normes européennes 91/156/etc Informations environnementales sur la sécurité:** la nature périssable du produit, sur la base de sa composition, est pratiquement nulle. Les résines ne figurent pas dans la liste établie par la norme de classification des déchets de matériaux soumis à une surveillance particulière. Les résines expansées ne contiennent pas de fréon ni de solvants chlorés. Les résines expansées ne contiennent pas de substances nuisibles à la couche d'ozone et ne sont pas fabriquées avec des produits figurant dans le Protocole de Montréal et le Règlement (CE) n° 3093/94. **Appui-tête cylindrique et coussin** entièrement recouvert de tissu.

Pieds et accessoires - Pieds en métal, de différentes formes, peints avec peinture époxy et chromés.

Suspension - La suspension est réalisée avec des bandes de 80 mm mécaniquement tendues, composées de fils de nylon enroulés en spirale.

Elementi fissi / Fixed units / Éléments fixes



Spessore bracciolo
Armrest thickness
Épaisseur accoudoir

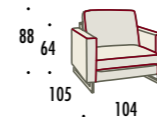

Art. 01
Poltrona Small
Armchair Small
Fauteuil Small

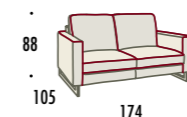

Art. 02
Divano 2 posti Small
2-seater sofa Small
Canapé 2 places Small

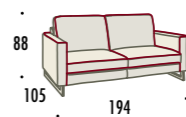

Art. 20
Divano 2 posti Midi
2-seater sofa Midi
Canapé 2 places Midi

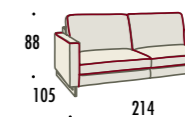

Art. 03
Divano 3 posti Large
3-seater sofa Large
Canapé 3 places Large

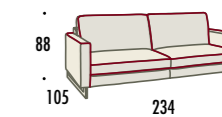

Art. 06
Divano 3 posti Big
3-seater sofa Big
Canapé 3 places Big

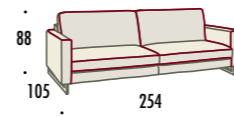

Art. 07
Divano 3 posti Maxi
3-seater sofa Maxi
Canapé 3 places Maxi

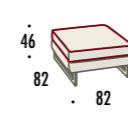

Art. 11
Pouf quadrato
Square pouf
Pouf carré

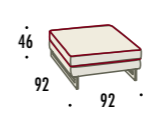

Art. 12
Pouf quadrato
Square pouf
Pouf carré

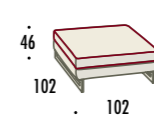

Art. 13
Pouf quadrato
Square pouf
Pouf carré

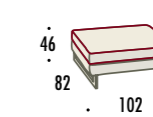

Art. 14
Pouf rettangolare
Rectangular pouf
Pouf rectangulaire

Elementi componibili / Modular units / Éléments composables

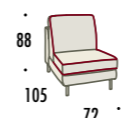

Art. 90
Elemento centrale Small
Central element Small
Chaufeuse Small

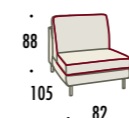

Art. 91
Elemento centrale Midi
Central element Midi
Chaufeuse Midi

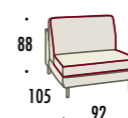

Art. 92
Elemento centrale Large
Central element Large
Chaufeuse Large

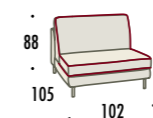

Art. 93
Elemento centrale Big
Central element Big
Chaufeuse Big

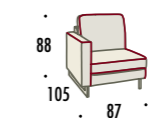

Art. dx SD - Art. sx SS
Laterale 1 posto Small DX-SX
RH-LH 1-seater side element Small
Canapé bâtarde 1 place Small D-G

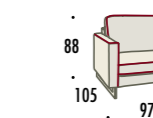

Art. dx MD - Art. sx MS
Laterale 1 posto Midi DX-SX
RH-LH 1-seater side element Midi
Canapé bâtarde 1 place Midi D-G

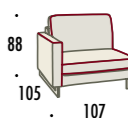

Art. dx LD - Art. sx LS
Laterale 1 posto Large DX-SX
RH-LH 1-seater side element Large
Canapé bâtarde 1 place Large D-G

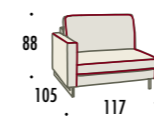

Art. dx BD - Art. sx BS
Laterale 1 posto Big DX-SX
RH-LH 1-seater side element Big
Canapé bâtarde 1 place Big D-G

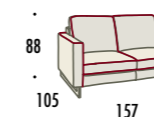

Art. dx 2D - Art. sx 2S
Laterale 2 posti Small DX-SX
RH-LH 2-seater side element Small
Canapé bâtarde 2 place Small D-G

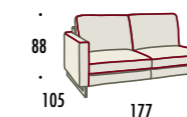

Art. dx GD - Art. sx GS
Laterale 2 posti Midi DX-SX
RH-LH 2-seater side element Midi
Canapé bâtarde 2 place Midi D-G

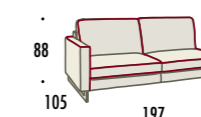

Art. dx 3D - Art. sx 3S
Laterale 3 posti Large DX-SX
RH-LH 3-seater side element Large
Canapé bâtarde 3 place Large D-G

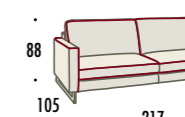

Art. dx 6D - Art. sx 6S
Laterale 3 posti Big DX-SX
RH-LH 3-seater side element Big
Canapé bâtarde 3 place Big D-G



Art. dx 7D - Art. sx 7S
Laterale 3 posti Maxi DX-SX
RH-LH 3-seater side element Maxi
Canapé bâtarde 3 place Maxi D-G

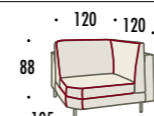

Art. AQ
Angolo quadro
Square corner
Angle carré

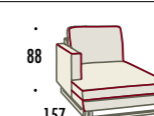

Art. dx CD - Art. sx CS
Chaise longue Midi DX-SX
RH-LH Chaise longue Midi
Mérienne Midi D-G

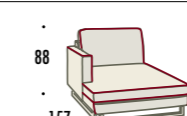

Art. dx CL - Art. sx LC
Chaise longue Large DX-SX
RH-LH Chaise longue Large
Mérienne Large D-G

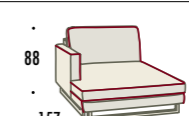

Art. dx CB - Art. sx BC
Chaise longue Big DX-SX
RH-LH Chaise longue Big
Mérienne Big D-G

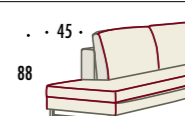

Art. dx TP - Art. sx PT
Terminale c/penisola Large DX-SX
RH-LH End element with peninsula Large
Terminal avec peninsula Large D-G

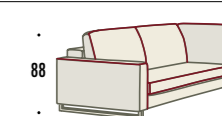

Art. dx LT - Art. sx TL
Laterale angolo Large DX-SX
RH-LH Corner side element Large
Latéral angle Large D-G



Art. 30
Poggiatesta saponetta
Soap-shaped headrest
Appui-tête a forme de savon

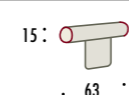

Art. 31
Poggiatesta cilindro
Cylinder-shaped headrest
Appui-tête a forme de cylindre

Piede TWINNY a doppio stiletto H. 14 / Double stiletto TWINNY foot H. 14 / Pied TWINNY double talon H. 14



Barra ICE H.14 / ICE bar H.14 / Barre ICE H.14



Optional poggiatesta / Optional headrest / Option appui-tête



Esempio composizione / Layout example / Exemple de composition

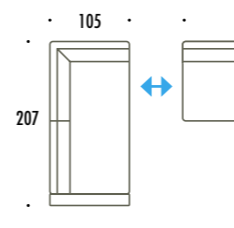

Art. dx LT - Art. sx TL + Art. dx 3D - Art. sx 3S
Laterale angolo Large DX-SX + Laterale 3 posti Large DX-SX
RH-LH Corner side element Large + RH-LH 3-seater side element Large
Latéral angle Large D-G + Canapé bâtarde 3 place Large D-G

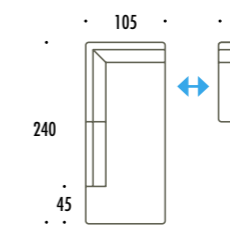

Art. dx TP - Art. sx PT + Art. dx 3D - Art. sx 3S
Terminale c/penisola Large DX-SX + Laterale 3 posti Large DX-SX
RH-LH End element with peninsula Large + RH-LH 3-seater side element Large
Terminal avec peninsula Large D-G + Canapé bâtarde 3 place Large D-G



Ajar

Proporzioni importanti, seduta profonda, appoggio extralarge, schienale di grandi dimensioni.

Major proportions, deep seat, extralarge support, large backrest.

D'importantes proportions, une assise profonde, un appui extra-large et un dossier de grandes dimensions.





Ajar



Ajar



**Total comfort.
Lo schienale può diventare decisamente più alto grazie all'utilizzo del poggiatesta regolabile: consente l'appoggio e il sostegno anche completo di collo e testa per un relax veramente totale.**

Total comfort.
The backrest can be made much higher thanks to the adjustable headrest: it allows complete support of neck and head for total relax.

Un confort total.
Le dossier peut être largement relevé grâce à l'utilisation de l'appui-tête réglable : permet également l'appui et le soutien du cou et de la tête pour une détente complète.



6
posizioni

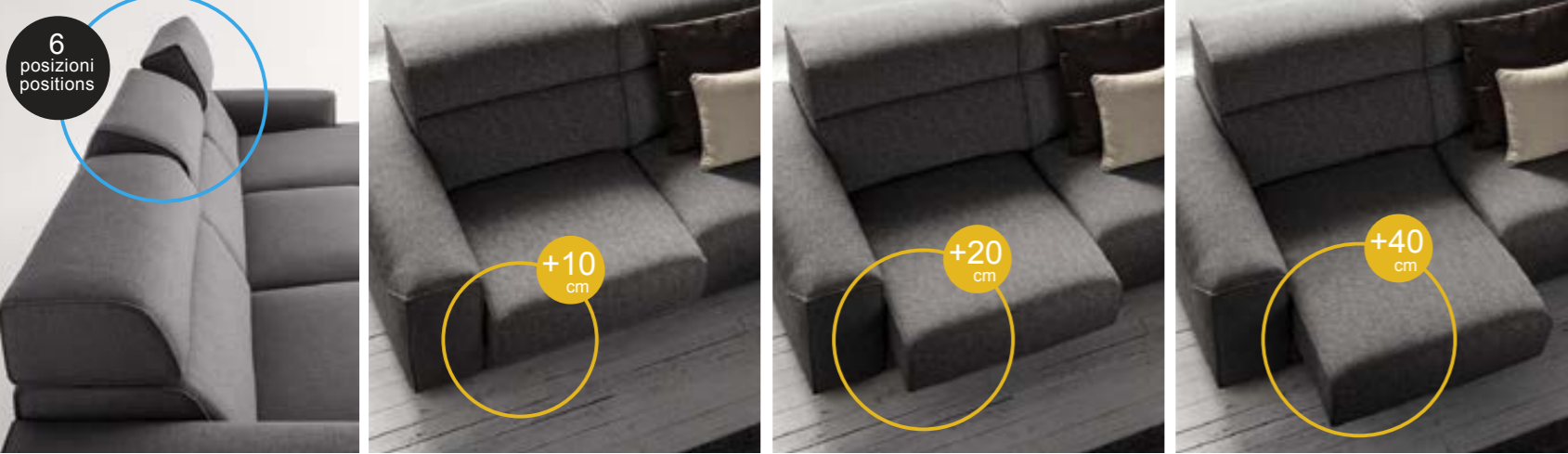

Ajar total comfort versione con poggiatesta e sedute regolabili

- + POSIZIONI**
- + SPAZIO**
- + RELAX**

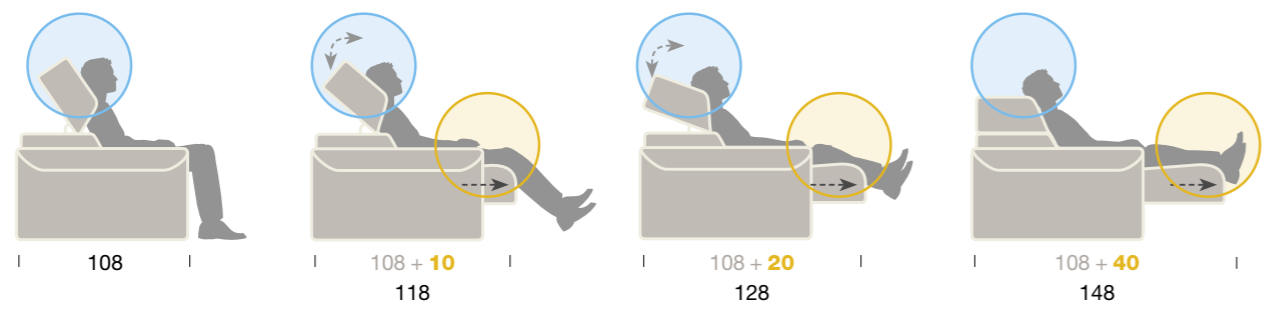

Per le sedute meccanismi a scivolamento brevettato per allungare le sedute. Con un semplice movimento la seduta avanza in tre diverse posizioni per aumentare la profondità (+ 10/20/40). Facile e confortevole appoggiare le gambe. Per lo schienale più altezza e sostegno grazie al poggiatesta ergonomico regolabile manualmente in 6 diverse posizioni per un maggiore appoggio. Comfort totale, relax, salute.

Ajar total comfort optional headrest and adjustable chairs. More positions, more space, more RELAX. Patented sliding mechanisms to lengthen the seats. With a simple movement the seat moves forward in three different positions to increase the depth (+ 10/20/40). Stretch your legs easily and comfortably. More height and support for the backrest, thanks to the manually adjustable headrest in 6 different positions for greater support. Total comfort, relaxation, health.

Ajar confort total version avec appui-tête et sièges réglables + positions, + espace, + RELAX. Pour les assises, des mécanismes à coulissement brevetés pour allonger le siège. Avec un simple mouvement, le siège avance dans trois positions différentes pour augmenter la profondeur (+ 10/20/40). Facile et confortable pour allonger les jambes. Une majeure hauteur et un plus grand soutien pour le dossier grâce à l'appui-tête ergonomique réglable manuellement dans 6 positions différentes. Confort total, détente, santé.





Per il rivestimento i doppi bordi in evidenza risultano da una cucitura doppia ribattuta, a bordi pizzicati. Il segno evidente disegna la sezione laterale delle cuscinerie e allarga il lato d'appoggio degli ampi braccioli.

For the cover, the clearly visible double borders result from a double flat fell seam, pinched at the edges. The obvious mark outlines the side of the cushions and widens the support side of the wide armrests.

Concernant le revêtement, les doubles bords mis en évidence sont le résultat d'une double couture rabattue, à bords pincés. Le signe évident dessine la section latérale des coussins et élargit la partie de support des vastes accoudoirs.







Anche la versione 2 posti, contenuta e compatta, è importante, comoda, accogliente... Nella versione con seduta mobile e poggiatesta regolabile per un comfort più "riposante".

Even the 2-seater sofa, contained and compact, is prominent, comfortable and cozy... In the version with movable seat and adjustable headrest, for a more "restful comfort".

La version 2 places, compacte, reste néanmoins importante, confortable et chaleureuse... Dans la version avec siège mobile et appuie-tête réglable, pour un plus confort encore plus «reposant».

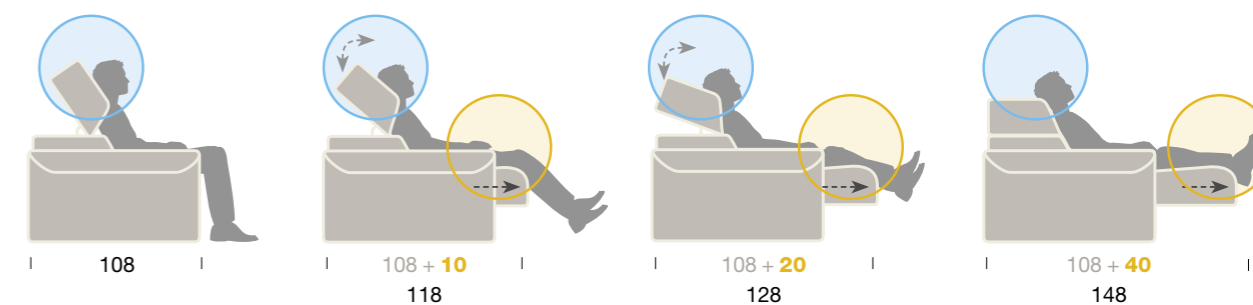

Ajar

Completamente sfoderabile
Totally removable cover
Complètement déhoussable

Caratteristiche tecniche

Struttura - Realizzata con masselli portanti in legno massiccio di abete in vari spessori. Fianchi e parti strutturali in multistrato di abete da 18 mm, parti di tamponamento in agglomerato di legno di spessore 18mm e 4 mm. Il tutto trattato al naturale in classe E1, pertanto a bassa emissione di formaldeide. Il telaio è completamente rivestito con vellutino 100% poliammine termo accoppiato ad espanso 100% polietero e/o ovatta resinato da 200 gr di 100% poliester.

Imbottitura

Cuscino seduta: doppia densità in poliuretano espanso flessibile 35 softy/40 indeformabile con bombatura in espanso flessibile in D40 indeformabile applicato a telaio in metallo, nella versione con seduta mobile a tre posizioni, e rivestito completamente con vellutino in poliammine 100% accoppiato a resinato di poliester da 200g.

Schienale in poliuretano espanso flessibile e indeformabile in D23HS.

Poggiatesta in poliuretano espanso flessibile e indeformabile, sagomato in D16S più fianchi in D40, rivestito in resinato di poliester da 300 g.

Braccioli in poliuretano espanso flessibile e indeformabile sagomato in D26NY più fianchi interni in D18 più resinato di poliester 100% da 300g. **Informazioni ambientali sulla sicurezza:** la deperibilità del prodotto, secondo la sua composizione, è praticamente nulla. Le resine non sono contenute nella lista della normativa di classificazione dei rifiuti per materiali soggetti a particolare sorveglianza. Le resine espanso sono esenti da freon e solventi clorurati. Le resine espanso non contengono sostanze che danneggiano l'ozonofera e non vengono fabbricate con prodotti menzionati nel protocollo di Montreal e Regolamento (CE) n. 3093/94.

Piedino in abs nero da 4 cm posizionati non visibili.

Molleggio

Per la versione con seduta mobile: telaio in metallo verniciato a polveri epossidiche, con controrelaio scorrevole su cuscinetti a sfera, cinghiato con cinghie elastiche intrecciate. Il poggiatesta è assistito da cricchetto a n°6 posizioni inserito nella struttura a "baionetta".

Per la versione fissa: il molleggio è realizzato in nastri da 80 mm tesi meccanicamente, composta da fili di nylon avvolto a spirale. Ajar (bracciolo dritto) e Winston (bracciolo inclinato) con seduta estraibile e poggiatesta con cricchetto.

N.B i modelli Ajar e Winston hanno la seduta estraibile su telaio in metallo ed il poggiatesta con cricchetto a n° 6 posizioni inserito alla struttura a "baionetta". Ajar e Winston possono essere forniti anche con seduta e poggiatesta non mobili o "fissi".

Optional: seduta estraibile e cricchetto

Optional: removable seat and ratchet / En option: assise amovible et système à cliquet

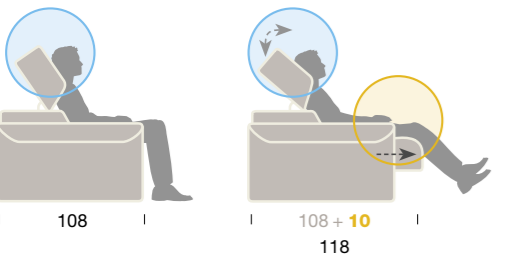

Technical characteristics

Structure - Made with bearing parts in solid fir wood in various thicknesses. 18mm fir plywood sides and structural parts, 18mm and 4 mm thick particle wood infill parts. All treated naturally in Class E1, thus with low formaldehyde emissions The frame is completely covered with 100% polyamines velveteen thermo-coupled with 100% polyether foam and/or 200 g. 100% polyester wadding resin.

Padding

Seat cushion: Double density 35 softy/40 flexible non-deformable polyurethane foam, with flexible non-deformable D40 foam camber applied to the metal frame, in the version with three-position movable seat, and completely covered with 100% polyamine velvet coupled with 200g. polyester resin.

Flexible and non-deformable polyurethane foam **backrest**, D23HS.

Flexible and non-deformable polyurethane foam **headrests**, D16S profiled with D40 sides, covered with 300g polyester resin.

Flexible and non-deformable polyurethane foam **armrests**, D26NY profiled with D18 internal sides, covered with 100% 300g polyester resin.

Environmental information on safety: The perishable nature of the product, according to its composition, is practically nil. Resins are not included in the list of standards for the classification of waste materials subject to special surveillance. Resin foams are free from freon and chlorinated solvents. Resin foams do not contain substances that damage the ozone layer and are not manufactured with products mentioned in the Montreal Protocol and (CE) Regulation no. 3093/94.

Black abs 4 cm **feet**, not visible.

Springs

Mobile seat version: epoxy powder coated metal frame, with counter-frame sliding on ball bearings, strapped with braided elastic straps. The headrest is assisted by a 6-position ratchet inserted into the "bayonet structure."

Fixed version: the springing is made of 80 mm mechanically stretched strips, composed of nylon wires wound in a spiral Ajar (straight armrest) and Winston (tilted armrest) with removable seat and headrest with ratchet. **Note:** the Ajar and Winston models have removable seats with metal frames and headrests with 6-position ratchet inserted into the "bayonet structure." Ajar and Winston can also be supplied with non-mobile, or "fixed", seat and headrest.

Bracciolo di 2 misure: 19 e 28 cm

Armrest in 2 sizes: 19 and 28 cm / Accoudoir 2 tailles: 19 et 28 cm

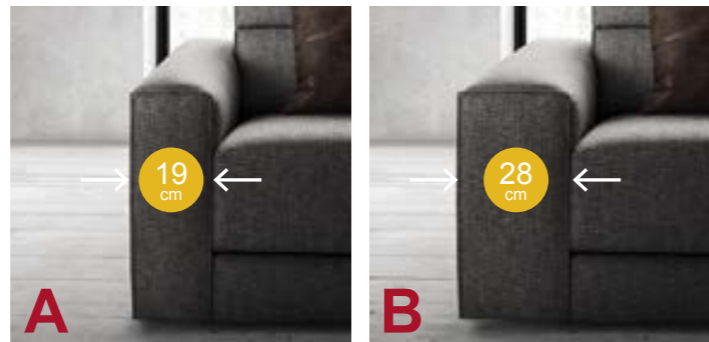

Ajar A



Spessore bracciolo
Armrest thickness
Épaisseur accoudoir

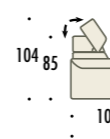

Spessore bracciolo
Armrest thickness
Épaisseur accoudoir

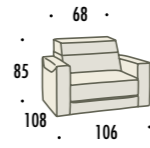

Art. 01
Poltrona
Armchair
Fauteuil

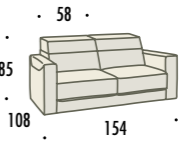

Art. 02
Divano 2 posti
2-seater sofa
Canapé 2 places

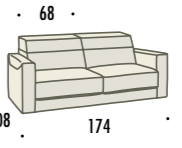

Art. 20
Divano 2 posti Grande
2-seater big sofa
Canapé 2 places grand

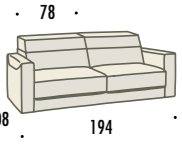

Art. 03
Divano 3 posti
3-seater sofa
Canapé 3 places

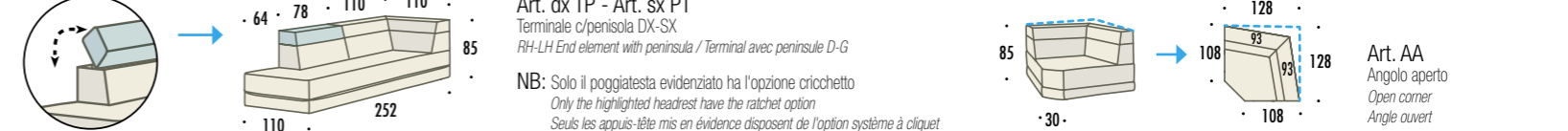
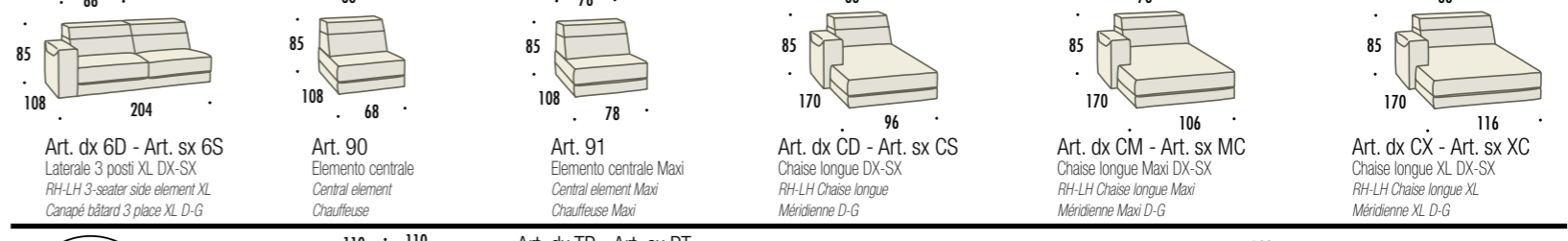
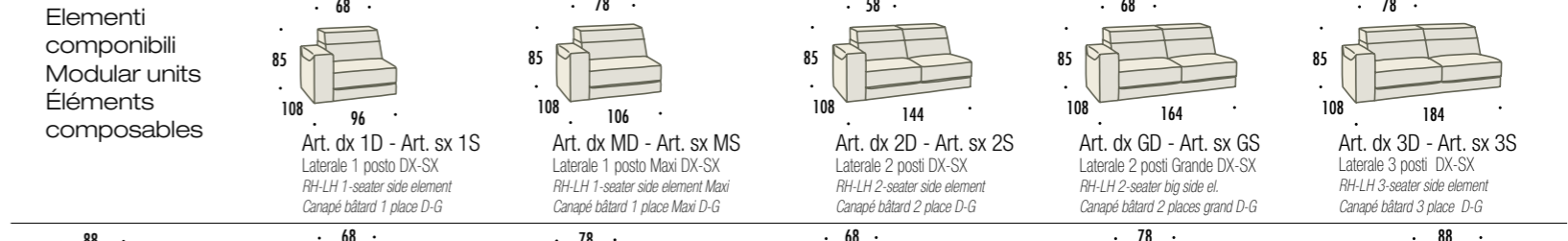
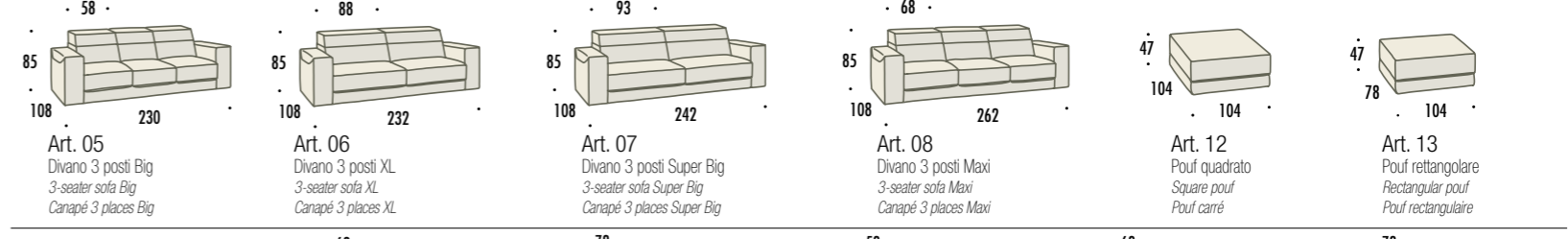
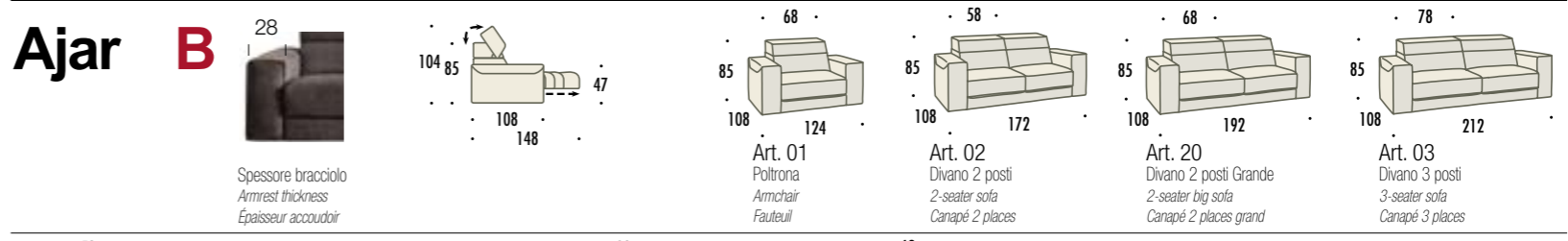
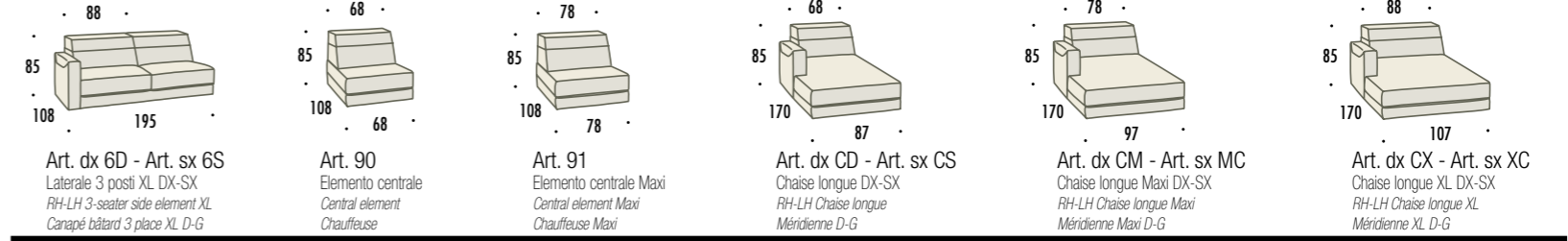
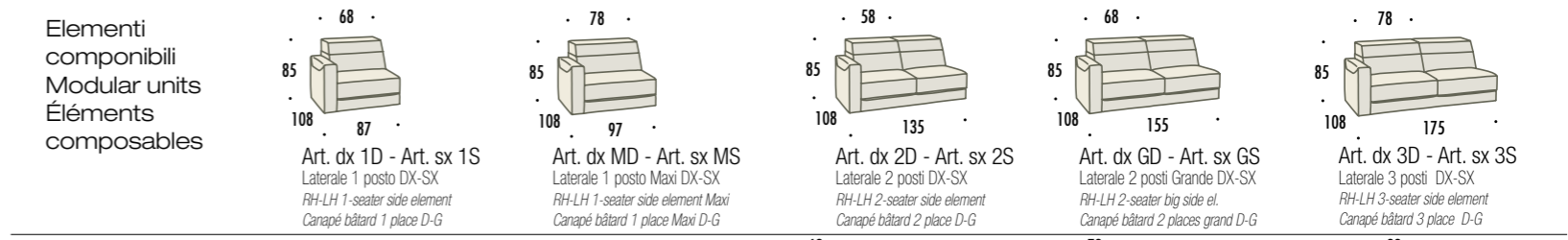
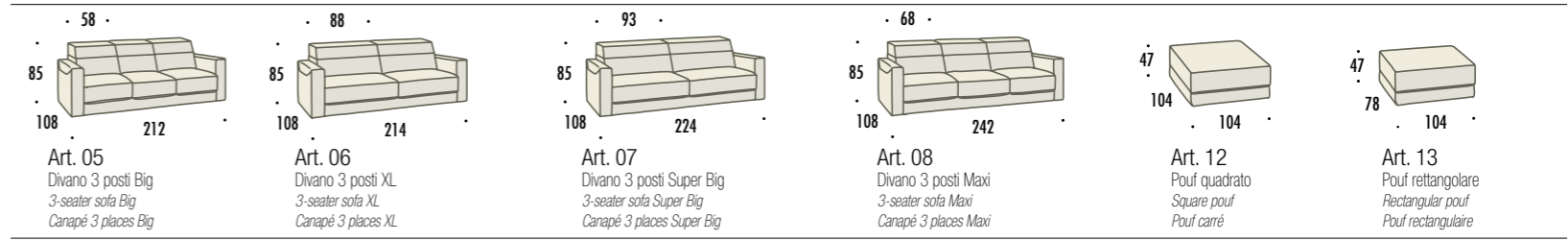

NB: Solo il poggiatesta evidenziato ha l'opzione cricchetto
Only the highlighted headrest have the ratchet option
Seuls les appuis-tête mis en évidence disposent de l'option système à cliquet



Winston

La scelta degli oggetti e dei piccoli complementi è emozione, presenza, tono e atmosfera... Per gli ambienti.

The choice of objects and small accessories creates emotions, presence, tone and atmosphere... For all environments.

Le choix des objets et des petits accessoires est émotion, présence, ton et atmosphère... Création d'ambiance.





Winston



**Personal relax.
Orari diversi,
funzioni diverse...
La libertà di
personalizzare
continuamente lo
“stile” di seduta.
Da quella formale
eretta con gli
ospiti a quella più
rilassata e comoda
per la sera, la tv, un
piccolo sonno...**

Personal relax.
Different times, different
functions... The freedom
to continually customize
the seat «style». From
the formal upright seat for
guests, to the more relaxed
and comfortable seat for the
evening, for watching TV,
or taking a nap...

Relax personnel.
Horaires différents, fonctions
différentes... La liberté de
personnaliser sans cesse
le «style» de l'assise.
De la forme verticale pour les
invités à celle plus détendue
et confortable de la soirée,
devant la télévision, pour
s'assoupir...

Winston

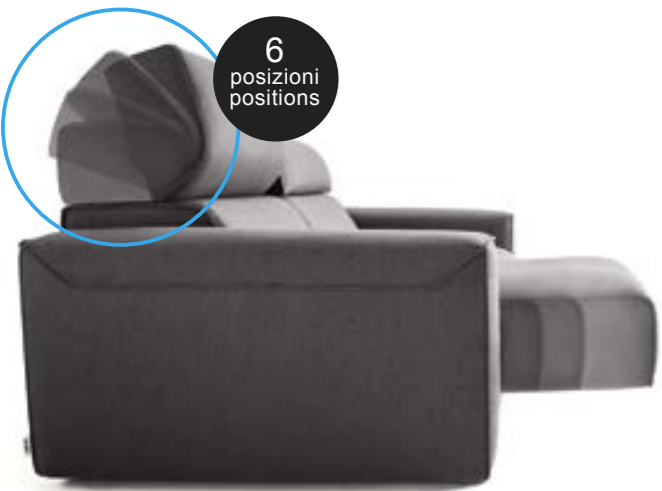

6
posizioni
positions



Winston è bello e si trasforma

- + POSIZIONI
- + SPAZIO
- + COMFORT

Per le sedute meccanismi a scivolamento brevettato per allungare le sedute. Con un semplice movimento la seduta avanza in tre diverse posizioni per aumentare la profondità (+ 10/20/40). Facile e confortevole appoggiare le gambe. Per lo schienale più altezza e sostegno grazie al poggiatesta ergonomico regolabile manualmente in 6 diverse posizioni per un maggiore appoggio. Comfort totale, relax, salute.

Winston it is beautiful and it can be transformed. More positions, more space, more comfort. Patented sliding mechanisms to lengthen the seats. With a simple movement the seat moves forward in three different positions to increase the depth (+ 10/20/40). Stretch your legs easily and comfortably. More height and support for the backrest, thanks to the manually adjustable headrest in 6 different positions for greater support. Total comfort, relaxation, health.

Winston est beau et se transforme + positions, + espace, + confort. Pour les assises, des mécanismes à coulissement brevetés pour allonger le siège. Avec un simple mouvement, le siège avance dans trois positions différentes pour augmenter la profondeur (+ 10/20/40). Facile et confortable pour allonger les jambes. Une majeure hauteur et un plus grand soutien pour le dossier grâce à l'appui-tête ergonomique réglable manuellement dans 6 positions différentes. Confort total, détente, santé.

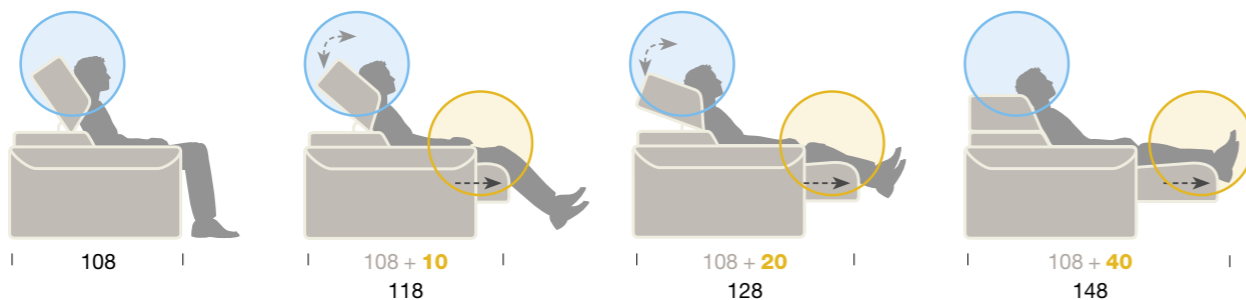

Winston





Winston



**Profili generosi,
tanti elementi
per tante diverse
personali
composizioni.
A contrasto e
complemento
coordinato.
Proposte di tavolini
in marmo e curiosi
piani d'appoggio:
sedute, pouf
imbottiti, di forme
e altezze diverse...**

Generous profiles, many parts for many different personal compositions. In contrasting and matching colours. Coffee marble tables and curious tops: seats upholstered ottomans with different shapes and heights...

Des montants généreux, de nombreux éléments pour de nombreuses compositions personnelles différentes. En contraste et complément coordonné. Propositions de tables En marbre avec de curieux plans d'appui: assises poufs rembourrés, de formes et hauteurs différentes...



**Serie multitasking
“seat-table-pouf”:
complementi unici,
funzioni diverse,
seduta, piano
d’appoggio, pouf
generico...
Pratico,
posizionabile a
piacere ovunque...
Pratici e simpatici.
Facili da spostare
ogni volta dove
serve.**

Multitasking series “seat-table-ottoman”: unique complements different functions, seat, table top, generic ottoman... Practical, positioned at will anywhere... Practical and cute. Always easy to move where it is needed.

Série multitasking « siège-table-pouf » : compléments uniques fonctions différentes, assise, plan d’appui, pouf générique... Pratique, à installer partout... Pratiques et sympathiques. Faciles à déplacer à tout moment.



Winston



Winston

Winston

Completamente sfoderabile
Totally removable cover
Complètement déhoussable



Caratteristiche tecniche

Struttura - Realizzata con masselli portanti in legno massiccio di abete in vari spessori. Fianchi e parti strutturali in multistrato di abete da 18 mm, parti di tamponamento in agglomerato di legno di spessore 18mm e 4 mm. Il tutto trattato al naturale in classe E1, pertanto a bassa emissione di formaldeide. Il telaio è completamente rivestito con vellutino 100% poliammine termo accoppiato ad espanso 100% polietero e/o ovatta resinato da 200 gr di 100% poliester.

Imbottitura

Cuscino seduta: doppia densità in poliuretano espanso flessibile 35 softy/40 indeformabile con bombatura in espanso flessibile in D40 indeformabile applicato a telaio in metallo, nella versione con seduta mobile a tre posizioni, e rivestito completamente con vellutino in poliammine 100% accoppiato a resinato di poliester da 200g.

Schienale in poliuretano espanso flessibile e indeformabile in D23HS.

Poggiatesta in poliuretano espanso flessibile e indeformabile, sagomato in D16S più fianchi in D40, rivestito in resinato di poliester da 300 g.

Braccioli in poliuretano espanso flessibile e indeformabile sagomato in D26NY più fianchi interni in D18 più resinato di poliester 100% da 300g.

Informazioni ambientali sulla sicurezza: la deperibilità del prodotto, secondo la sua composizione, è praticamente nulla. Le resine non sono contenute nella lista della normativa di classificazione dei rifiuti per materiali soggetti a particolare sorveglianza. Le resine espanso sono esenti da freon e solventi clorurati. Le resine espanso non contengono sostanze che danneggiano l'ozonostera e non vengono fabbricate con prodotti menzionati nel protocollo di Montreal e Regolamento (CE) n. 3093/94.

Piedino in abs nero da 4 cm posizionati non visibili.

Molleggio

Per la versione con seduta mobile: telaio in metallo verniciato a polveri epossidiche, con controtelaio scorrevole su cuscinetti a sfera, cinghiato con cinghie elastiche in trecciate. Il poggiatesta è assistito da cricchetto a n°6 posizioni inserito nella struttura a "baionetta".

Per la versione fissa: il molleggio è realizzato in nastri da 80 mm tesi meccanicamente, composta da fili di nylon avvolto a spirale. Ajar (bracciolo dritto) e Winston (bracciolo inclinato) con seduta estraibile e poggiatesta con cricchetto.

N.B i modelli Ajar e Winston hanno la seduta estraibile su telaio in metallo ed il poggiatesta con cricchetto a n° 6 posizioni inserito alla struttura a "baionetta". Ajar e Winston possono essere forniti anche con seduta e poggiatesta non mobili o "fissi".

Technical characteristics

Structure - Made with bearing parts in solid fir wood in various thicknesses. 18mm fir plywood sides and structural parts, 18mm and 4 mm thick particle wood infill parts. All treated naturally in Class E1, thus with low formaldehyde emissions. The frame is completely covered with 100% polyamines velveteen thermo-coupled with 100% polyether foam and/or 200 g. 100% polyester wadding resin.

Padding

Seat cushion: Double density 35 softy/40 flexible non-deformable polyurethane foam, with flexible non-deformable D40 foam camber applied to the metal frame, in the version with three-position movable seat, and completely covered with 100% polyamine velvet coupled with 200g. polyester resin.

Flexible and non-deformable polyurethane foam **backrest**, D23HS.

Flexible and non-deformable polyurethane foam **headrests**, D16S profiled with D40 sides, covered with 300g polyester resin. Flexible and non-deformable polyurethane foam **armrests**, D26NY profiled with D18 internal sides, covered with 100% 300g polyester resin.

Environmental information on safety: The perishable nature of the product, according to its composition, is practically nil. Resins are not included in the list of standards for the classification of waste materials subject to special surveillance. Resin foams are free from freon and chlorinated solvents. Resin foams do not contain substances that damage the ozone layer and are not manufactured with products mentioned in the Montreal Protocol and (CE) Regulation no. 3093/94.

Black abs 4 cm **feet**, not visible.

Springs

Mobile seat version: epoxy powder coated metal frame, with counter-frame sliding on ball bearings, strapped with braided elastic straps. The headrest is assisted by a 6-position ratchet inserted into the "bayonet structure."

Fixed version: the springing is made of 80 mm mechanically stretched strips, composed of nylon wires wound in a spiral Ajar (straight armrest) and Winston (tilted armrest) with removable seat and headrest with ratchet. **Note:** the Ajar and Winston models have removable seats with metal frames and headrests with 6-position ratchet inserted into the "bayonet structure." Ajar and Winston can also be supplied with non-mobile, or "fixed", seat and headrest.

Caractéristiques techniques

Structure - Réalisée avec des éléments porteurs en bois massif de sapin de différentes épaisseurs. Panneaux latéraux et éléments structuraux en bois de sapin stratifié de 18 mm, élément de remplissage en agglomérat de bois de 18 mm et 4 mm. Le tout traité au naturel en classe E1, soit à faible émission de formaldéhydes. Le cadre est entièrement recouvert de velours 100% polyamines couplé à chaud avec de la résine expansée 100% polyéther et/ou ouate de 200 g 100% polyester.

Rembourrage

Coussin d'assise: double densité en mousse de polyuréthane flexible 35 softy/40 indéformable avec bombage en mousse flexible D40 indéformable appliquée sur le cadre métallique, dans la version avec siège mobile à trois positions, et complètement recouvert de velours en polyamines 100% couplé à de la résine de polyester 200 g.

Dossier en mousse de polyuréthane flexible et indéformable en D23HS.

Appui-tête en mousse de polyuréthane flexible et indéformable formé avec D16S et panneaux latéraux en D40, recouvert de résine de polyester 300 g. **Accoudoirs** en mousse de polyuréthane flexible et indéformable formée en D26NY et panneaux latéraux en D18 avec résine de polyester 100% de 300g.

Informations environnementales sur la sécurité: la nature périssable du produit, sur la base de sa composition, est pratiquement nulle. Les résines ne figurent pas dans la liste établie par la norme de classification des déchets de matériaux soumis à une surveillance particulière. Les résines expansées ne contiennent pas de fréon ni de solvants chlorés. Les résines expansées ne contiennent pas de substances nuisibles à la couche d'ozone et ne sont pas fabriquées avec des produits figurant dans le Protocole de Montréal et le Règlement (CE) n° 3093/94. **Pied** en abs noir de 4 cm positionnés de façon invisible.

Suspension

Pour la version avec siège mobile: cadre en métal peint avec peinture époxy et contre-châssis coulissant sur roulements à billes, fixation avec sangles élastiques tressées. L'appui-tête est assisté par un système à cliquet à 6 positions inséré dans la structure à « baionnette ».

Pour la version fixe: la suspension est réalisée avec des bandes de 80 mm mécaniquement tendues, composées de fils de nylon enroulés en spirale. Ajar (accoudoir droit) et Winston (accoudoir incliné) avec siège amovible et appui-tête à cliquet.

N.B. les modèles Ajar et Winston présentent une assise amovible sur un cadre métallique et un appui-tête à cliquet à 6 positions inséré dans une structure à « baionnette ». Ajar et Winston peuvent également être fournis avec assise et appui-tête non mobiles ou « fixes ».

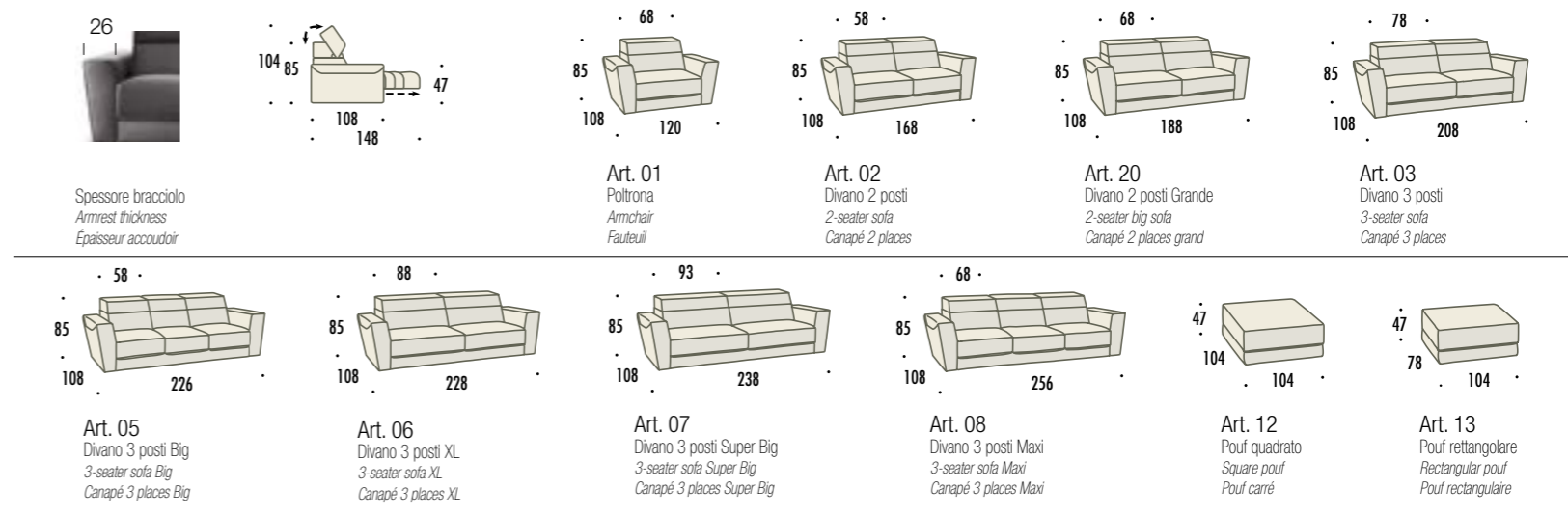

Elementi componibili / Modular units / Éléments composables

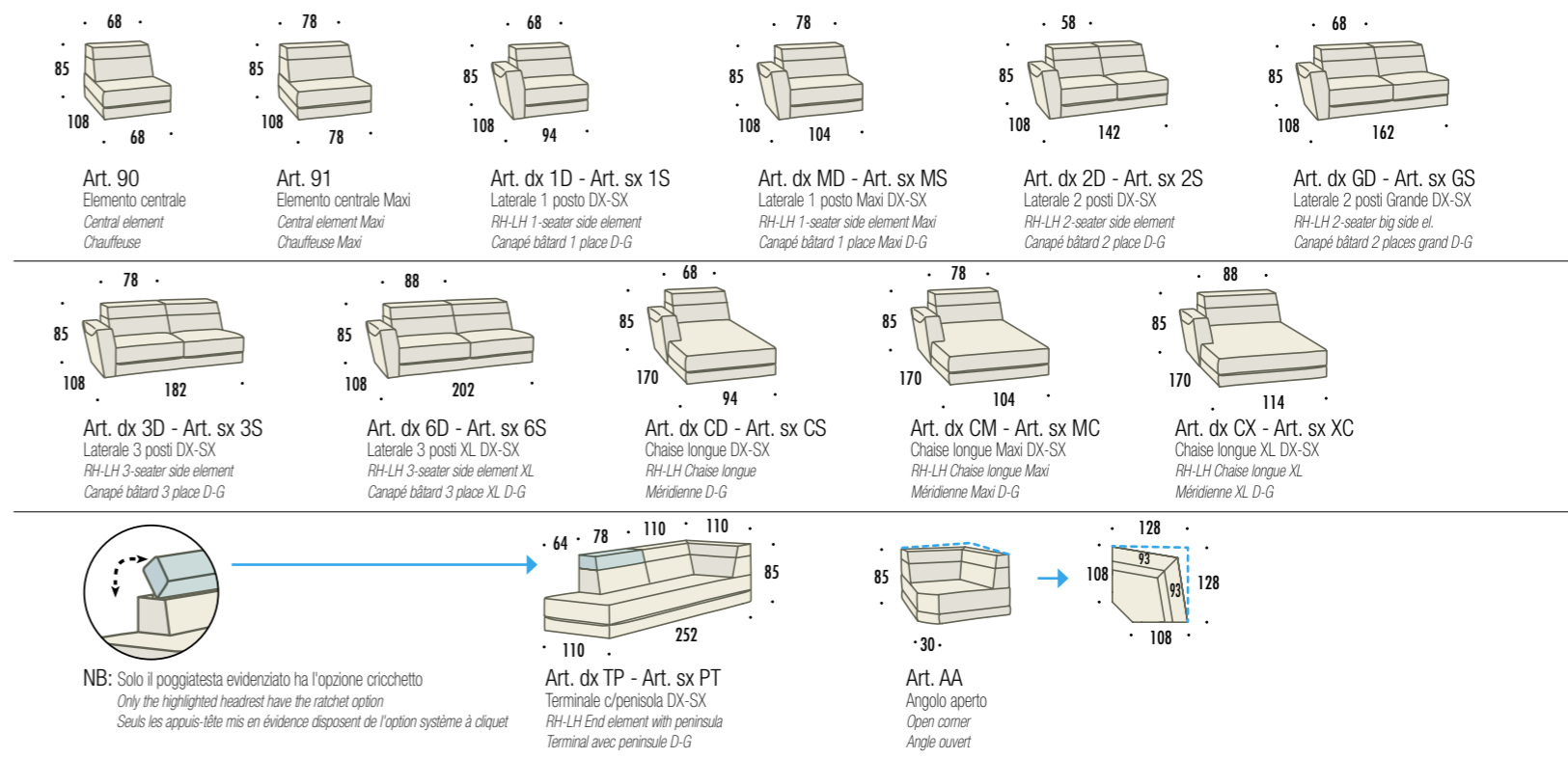

Optional: seduta estraibile e cricchetto / Optional: removable seat and ratchet / En option: assise amovible et système à cliquet

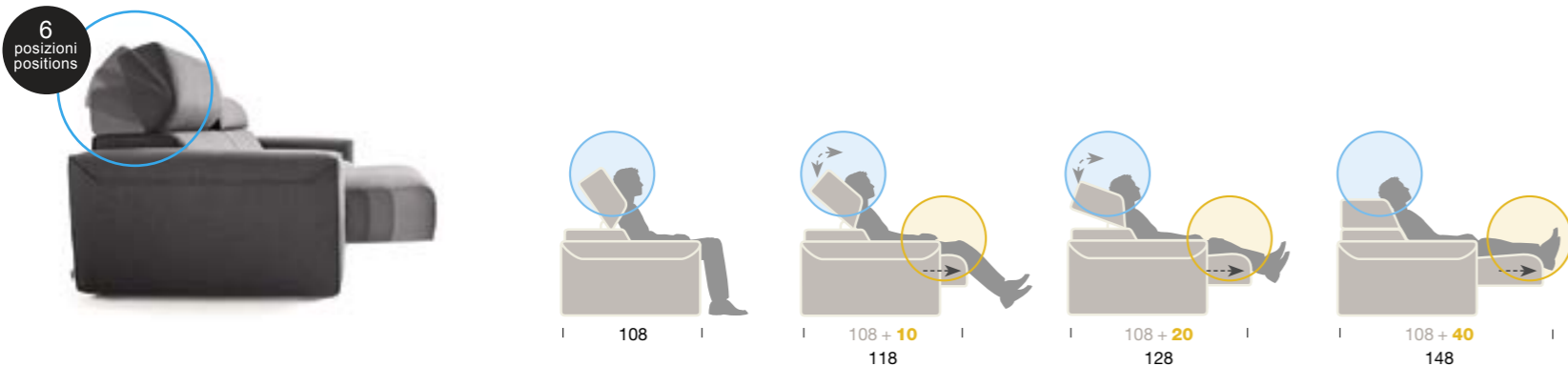



Angel

Possibilità compositiva per grandi spazi. Lusso discreto di linee continue, rigorose ma morbide, precise ma, insieme accoglienti.

Possible arrangements for large spaces. Discreet luxury of continuous lines, rigorous but soft, precise but cozy.

Possibilités de compositions pour les grands espaces. Luxe discret des lignes continues, rigoureuses mais délicates, précises mais chaleureuses à la fois.





Angel



Design e funzione.
Il design “continuum”
dei piedini Ice.
Sottili nell’appoggio,
robusti nel collegamento
agli angoli della struttura.
Eleganti nella finitura
brunita scura carbon look.

Design and function
The «continuum» design
of the Ice feet. Thin in supporting,
robust in connecting with the corners
of the structure. Stylish with their dark
carbon look burnished finish.

Design et fonction.
Le design «continuum» des pieds Ice.
Fins dans leur soutien.
Et élégants dans les finitions
sombres carbon look.





Angel



**Disponibili due diversi
poggiatesta coordinati,
a sezione tonda o
a cuscino classico
posizionabili a piacere.**

Available with two different
coordinated headrests, round
or with classic cushion, which
can be positioned as desired.

Disponibles avec deux appuis-tête
différents coordonnés,
ronds ou en coussin classique
à positionner au souhait.

Angel





Angel

Compatto e formale, semplice e sofisticato, la seduta ampia e comoda. Linee rigorose, design minimal in evidenza il contrasto di materiali. Identità, funzione, sostegno, durata.



Compact and formal, simple and sophisticated, with a wide and comfortable seat. Rigorous lines, minimal design contrasting materials. Identity, function, support, durability.

Compact et formel, simple et sophistiqué, avec une assise large et confortable. Des lignes rigoureuses, un design minimaliste pour souligner le contraste des matériaux. Identité, fonction, soutien, durabilité.



Angel

**I particolari sartoriali e la possibilità di personalizzare la propria composizione...
Due possibilità di bordo applicato (a contrasto o in tinta) con doppia cucitura ribattuta (sempre della tinta del tessuto).**



The tailoring details and the ability to customize each composition... Two possibilities of applied edge (contrasting or matching colours) with flat fell double stitching (same colour of the fabric).



Les détails des coutures et la possibilité de personnaliser sa propre composition... Deux possibilités de bordure appliquée (en contraste ou ton sur ton) avec double couture rabattue (toujours de la couleur du tissu).

Angel

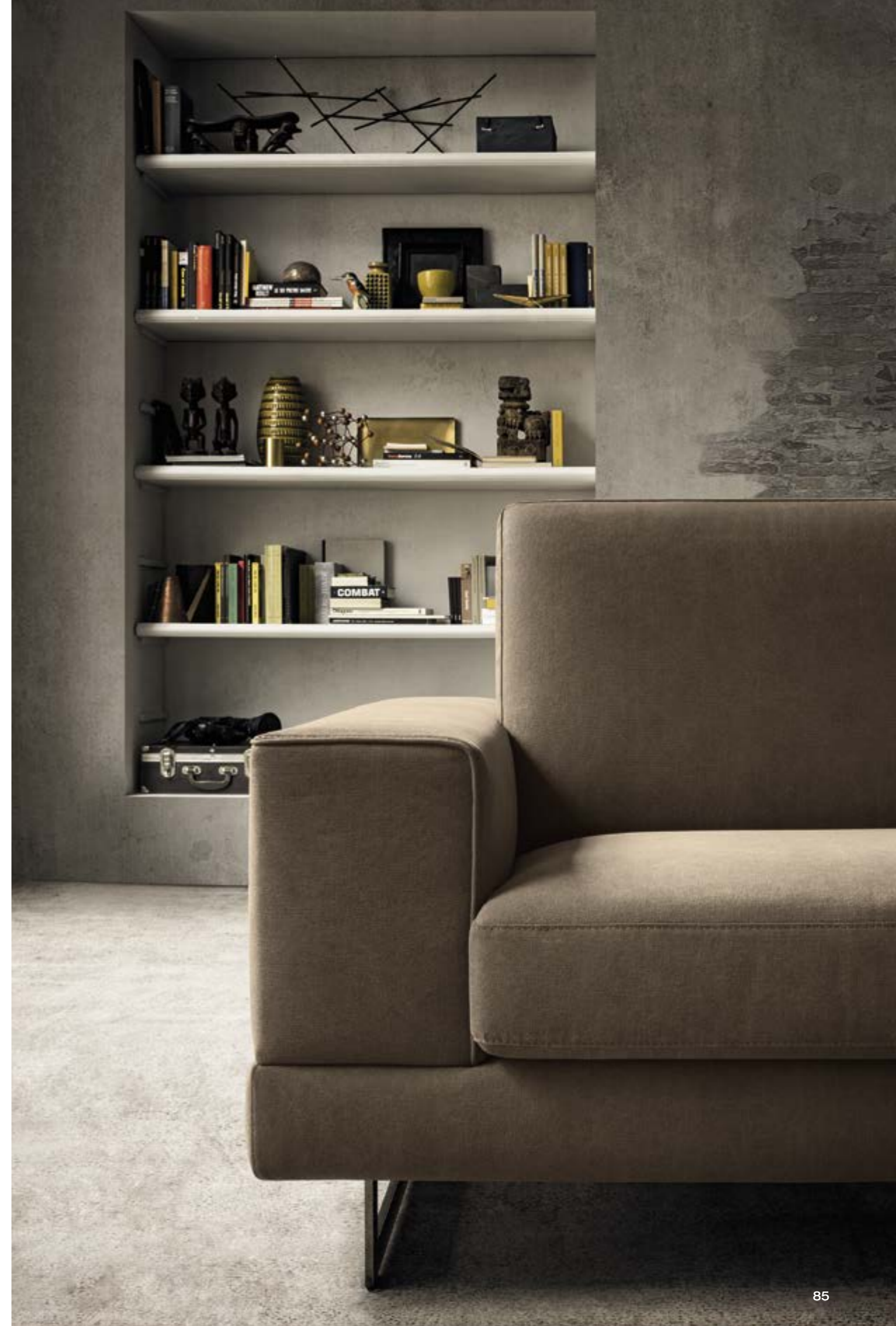



Angel

Angel

Completamente sfoderabile
Totally removable cover
Complètement déhoussable



Caratteristiche tecniche

Struttura - Realizzata con masselli portanti in legno massiccio di abete o pino da 18 mm, parti di tamponamento in agglomerato di legno di spessore 18mm e 4 mm. Il tutto trattato al naturale in classe E1, pertanto a bassa emissione di formaldeide. Il telaio è completamente rivestito con vellutino 100% poliammine termo accoppiato ad espanso 100% polietero e/o ovatta resinato da 200 gr di 100% poliester.

Imbottitura - Cuscino seduta in poliuretano espanso flessibile e indeformabile in densità D35 SR rivestito in falda termolegata da 300 gr in poliestere 100%. Cuscino schiena in poliuretano espanso flessibile e indeformabile in densità D18 morbido, rivestito in falda termolegata da 300 gr in 100% poliester.

Tamponi in espanso indeformabile D21.DPK40, bracciolo in D30 indeformabile rivestito in resinato da 200 gr in 100% poliester.

I materiali corrispondono alle normative europee 91/156/ etc. Informazioni ambientali sulla sicurezza: la deperibilità del prodotto, secondo la sua composizione, è praticamente nulla. Le resine non sono contenute nella lista della normativa di classificazione dei rifiuti per materiali soggetti a particolare sorveglianza. Le resine espanso sono esenti da freon e solventi clorurati. Le resine espanso non contengono sostanze che danneggiano l'ozonosfera e non vengono fabbricate con prodotti menzionati nel protocollo di Montreal e Regolamento (CE) n. 3093/94.

Poggiatesta a cilindro e a cuscinetto totalmente rivestiti in tessuto e fissati su telaio in metallo.

Piedini ed accessori - Piedini in metallo a "slitta" modello ICE.

Molleggio - Il molleggio è realizzato in nastri da 80 mm tesi meccanicamente, composta da fili di nylon avvolto a spirale.

Technical characteristics

Structure - Made with bearing parts in solid fir wood in various thicknesses. 18mm fir or pine plywood sides and structural parts, 18mm and 4 mm thick particle wood infill parts. All treated naturally in Class E1, thus with low formaldehyde emissions. The frame is completely covered with 100% polyamines velvetten thermo-coupled with 100% polyether foam and/or 200 g. 100% polyester wadding resin.

Padding - Flexible and non-deformable polyurethane foam seat cushion, density D35 SR, coated with 300 gr layer-bonded 100% polyester Flexible and non-deformable polyurethane foam back cushion, density D35 SR, coated with 300 gr layer-bonded 100% polyester.

Non-deformable polyurethane foam pads, D21, DPK40; non-deformable armrest, D30, coated with 200 gr layer-bonded 100% polyester.

The materials meet the European standards 91/156/ etc. Environmental information on safety: The perishable nature of the product, according to its composition, is practically nil. Resins are not included in the list of standards for the classification of waste materials subject to special surveillance. Resin foams are free from freon and chlorinated solvents. Resin foams do not contain substances that damage the ozone layer and are not manufactured with products mentioned in the Montreal Protocol and (CE) Regulation no. 3093/94.

Cylinder and pad headrest completely coated with fabric and fixed on a metal frame.

Feet and accessories - "slide" metal feet, ICE model.

Springing - The springing is made of 80 mm mechanically stretched strips, composed of nylon wires wound in a spiral.

Caractéristiques techniques

Structure - Réalisée avec des éléments porteurs en bois massif de sapin de différentes épaisseurs. Panneaux latéraux et éléments structuraux en bois de sapin stratifié de 18 mm, élément de remplissage en agglomérat de bois de 18 mm et 4 mm. Le tout traité au naturel en classe E1, soit à faible émission de formaldéhydes. Le cadre est entièrement recouvert de velours 100% polyamines couplé à chaud avec de la résine expansée 100% polyéther et/ou ouate de 200 g 100% polyester.

Rembourrage - Coussin d'assise en mousse de polyuréthane souple et indéformable densité D35 SR revêtu en couche collée de 300 g 100% polyester. Coussin de dossier en mousse de polyuréthane souple et indéformable densité D18 moelleux, revêtu en couche collée de 300 g 100% polyester. Éléments de remplissages en mousse indéformable D21, DPK40, accoudoir en D30 indéformable revêtu de résine 200 g 100% polyester.

Les matériaux sont conformes aux normes européennes 91/156/etc Informations environnementales sur la protection: la nature périssable du produit, sur la base de sa composition, est pratiquement nulle. Les résines ne figurent pas dans la liste établie par la norme de classification des déchets de matériaux soumis à une surveillance particulière. Les résines expansées ne contiennent pas de fréon ni de solvants chlorés. Les résines expansées ne contiennent pas de substances nuisibles à la couche d'ozone et ne sont pas fabriquées avec des produits figurant dans le Protocole de Montréal et le Règlement (CE) n° 3093/94.

Appui-tête cylindrique et en forme de coussin totalement revêtus de tissu et fixés au cadre métallique

Pieds et accessoires - Pieds en métal « coulissants » modèle ICE.

Suspension - La suspension est réalisée avec des bandes de 80 mm mécaniquement tendues, composées de fils de nylon enroulés en spirale.

Elementi fissi / Fixed units / Éléments fixes

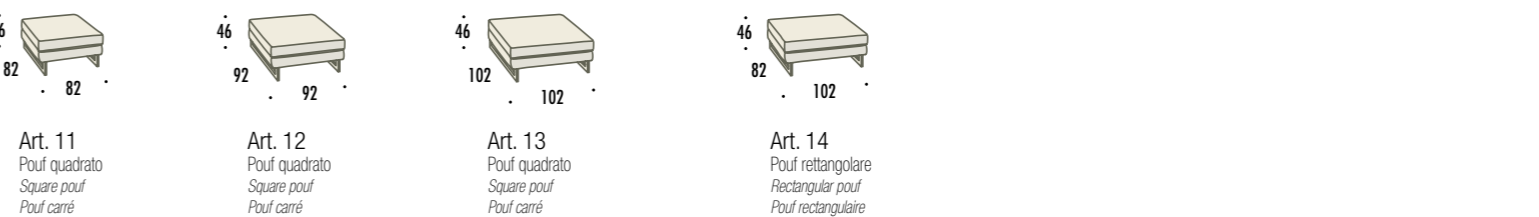
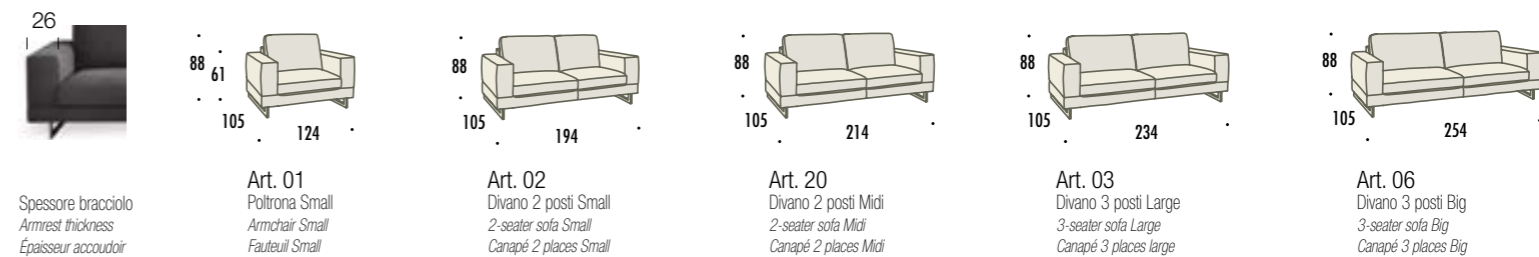

Elementi componibili / Modular units / Éléments composables

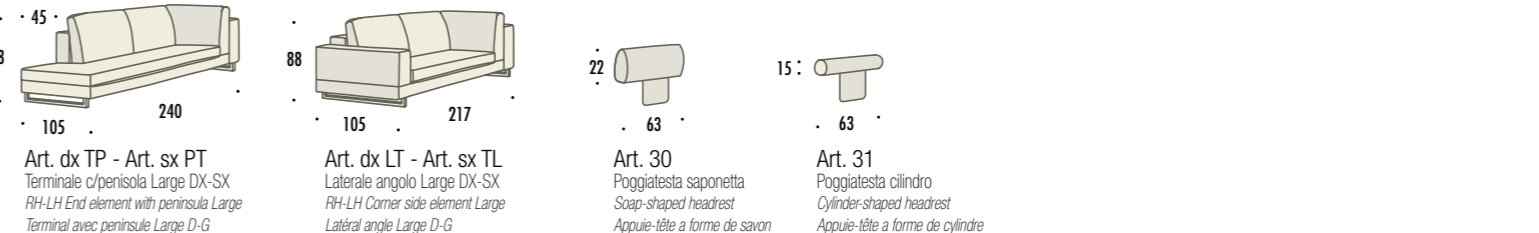
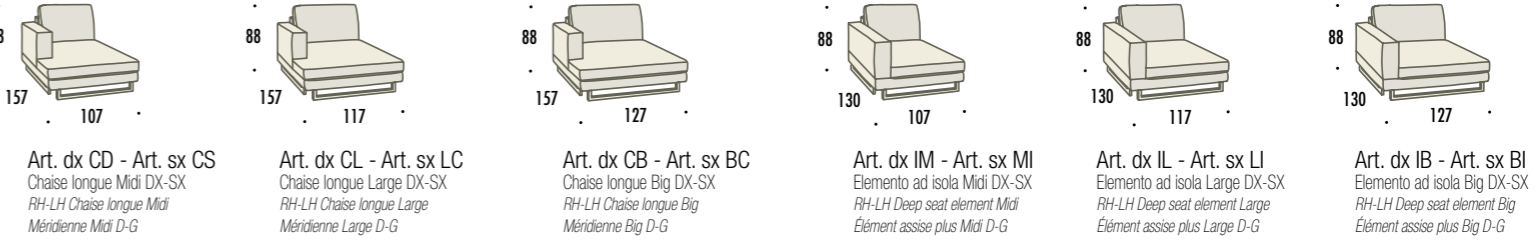
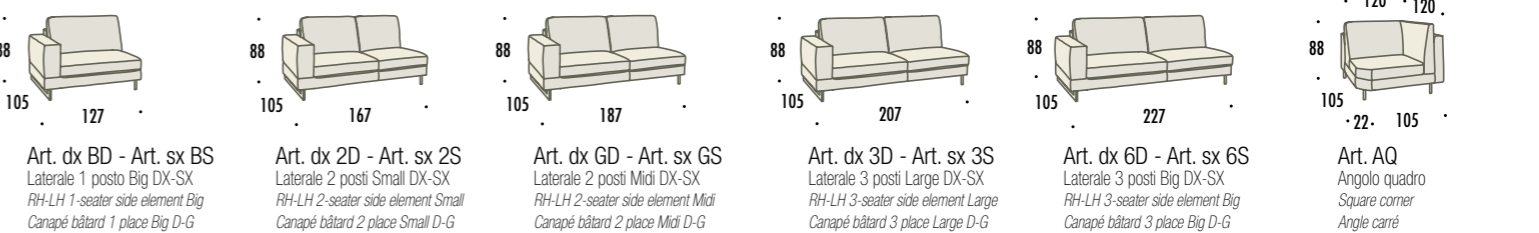
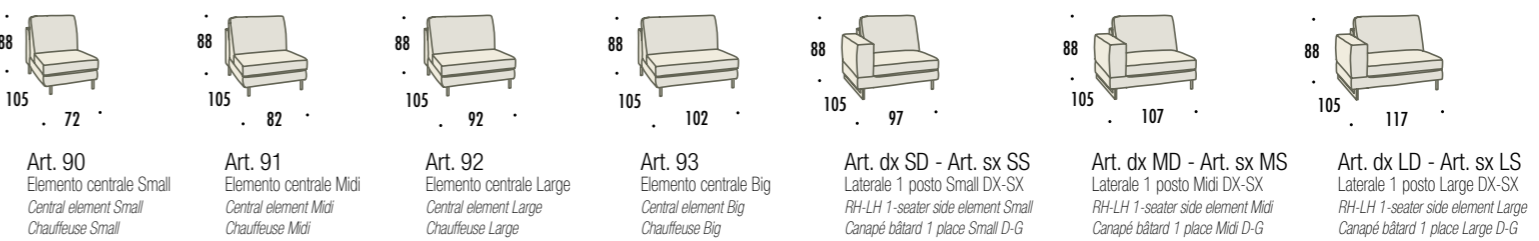

Esempio composizione / Layout example / Exemple de composition

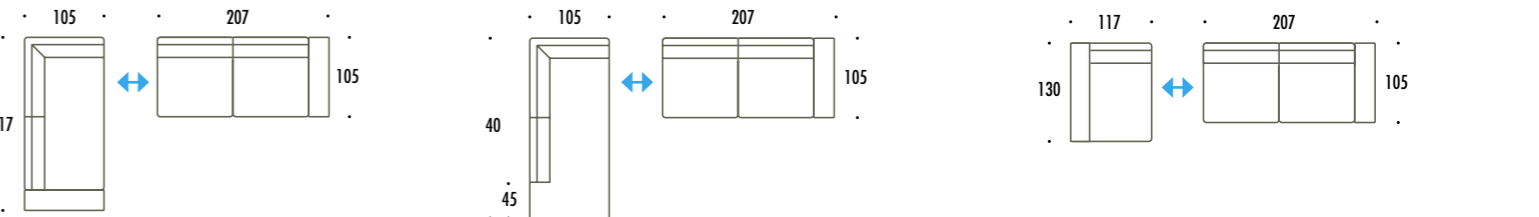

Art. dx LT - Art. sx TL + Art. dx 3D - Art. sx 3S
Laterale angolo Large DX-SX + Laterale 3 posti Large DX-SX
RH-LH Corner side element Large + RH-LH 3-seater side element Large
Latéral angle Large D-G+ Canapé bâtarde 3 place Large D-G

Art. dx TP - Art. sx PT + Art. dx 3D - Art. sx 3S
Terminale c/penisola Large DX-SX + Laterale 3 posti Large DX-SX
RH-LH End element with peninsula Large + RH-LH 3-seater side element Large
Terminal avec peninsula Large D-G+ Canapé bâtarde 3 place Large D-G

Art. dx IL - Art. sx LI + Art. dx 3D - Art. sx 3S
Elemento ad isola Large DX-SX + Laterale 3 posti Large DX-SX
RH-LH Deep seat element Large + RH-LH 3-seater side element Large
Élément assise plus Large D-G+ Canapé bâtarde 3 place Large D-G

Barra ICE H.14 / ICE bar H.14 / Barre ICE H.14



Carbon look lucido
Shining Carbon look
Carbon look brillant

Optional poggiatesta / Optional headrest / Option appui-tête



Optional bordo a contrasto / Optional contrasting border / En option bordure en contraste





Aspen

Forma moderna, compatta e decisa. Ma insieme morbido e accogliente per sedute e appoggi di comfort. Piedini di sostegno evidenti in legno naturale massiccio. Molto caratterizzanti ed eco-green emotion.

An advanced, compact and strong shape. But soft and cozy for comfortable seats and supports. Support feet in view made of solid natural wood. Very characteristic and eco-green emotion.

Forme moderne, compacte et forte. Mais également moelleuse et chaleureuse pour une assise et un soutien confortable. Pieds de soutien en bois massif naturel, pour une émotion écologique.





Aspen



Forme di un moderno ormai classico, aggiornate dal design zoomorfo e dalla particolare lavorazione dei piedini in legno naturale massiccio. Inclinati all'esterno e svasati danno emozione e uno stile eco-fashion.

Modern classic shapes, made contemporary by the zoomorphic design and the special processing, of the support feet made of solid natural wood. Tilted on the outside and flared, they provoke emotions with their eco-fashion style.

Formes modernes désormais classiques, actualisées par un design zoomorphe et un traitement spécial, pour les pieds de support en bois massif naturel. Inclinés à l'extérieur et évasés, ils confèrent une émotion et un style actuel.

Aspen





Aspen

Aspen

Completamente sfoderabile
Totally removable cover
Complètement déhoussable



Caratteristiche tecniche

Struttura - Realizzata con masselli portanti in legno massiccio di abete in vari spessori. Fianchi e parti strutturali in multistrato di abete da 18 mm, parti di tamponamento in agglomerato di legno di spessore 18mm e 4 mm. Il tutto trattato al naturale in classe E1, pertanto a bassa emissione di formaldeide. Il telaio è completamente rivestito con vellutino 100% poliammine termo accoppiato ad espanso 100% polietero e/o ovatta resinato da 200 gr di 100% poliester.

Imbottitura - Cuscino seduta in poliuretano espanso flessibile e indeformabile in densità D35 SR rivestito in faldia termolegata da 300 gr in poliestere 100%. Cuscino schiena in poliuretano espanso flessibile e indeformabile in densità D18 morbido, rivestito in faldia termolegata da 300 gr in 100% poliestere. Tamponi in espanso indeformabile D21.DPK40, bracciolo in D30 indeformabile rivestito in resinato da 200 gr in 100% poliestere. **I materiali corrispondono alle normative europee 91/156/ etc. Informazioni ambientali sulla sicurezza:** la deperibilità del prodotto, secondo la sua composizione, è praticamente nulla. Le resine non sono contenute nella lista della normativa di classificazione dei rifiuti per materiali soggetti a particolare sorveglianza. Le resine espanso sono esenti da freon e solventi clorurati. Le resine espanso non contengono sostanze che danneggiano l'ozonofera e non vengono fabbricate con prodotti menzionati nel protocollo di Montreal e Regolamento (CE) n. 3093/94.

Poggiatesta a cilindro e a cuscinetto totalmente rivestiti in tessuto e fissati su telaio in metallo.

Piedini ed accessori - Piedini in rovere naturale, verniciato tabacco e grigio a poro aperto, assemblati a piastra in acciaio zincata.

Molleggio - il molleggio è realizzato in nastri da 80 mm tesi meccanicamente, composta da fili di nylon avvolto a spirale.

Technical characteristics

Structure - Made with bearing parts in solid fir wood in various thicknesses. 18mm fir plywood sides and structural parts, 18mm and 4 mm thick particle wood infill parts. All treated naturally in Class E1, thus with low formaldehyde emissions. The frame is completely covered with 100% polyamines velvetreen thermo-coupled with 100% polyether foam and/or 200 g. 100% polyester wadding resin.

Padding - Flexible and non-deformable polyurethane foam seat cushion, density D35 SR, coated with 300 gr layer-bonded 100% polyester Flexible and non-deformable polyurethane foam back cushion, density D35 SR, coated with 300 gr layer-bonded 100% polyester Non-deformable polyurethane foam pads, D21, DPK40; non-deformable armrest, D30, coated with 200 gr layer-bonded 100% polyester.

The materials meet the European standards 91/156/ etc. Environmental information on safety: The perishable nature of the product, according to its composition, is practically nil. Resins are not included in the list of standards for the classification of waste materials subject to special surveillance. Resin foams are free from freon and chlorinated solvents. Resin foams do not contain substances that damage the ozone layer and are not manufactured with products mentioned in the Montreal Protocol and (CE) Regulation no. 3093/94.

Cylinder and pad headrest completely coated with fabric and fixed on a metal frame.

Feet and accessories - Natural oak, tobacco and open pore painted grey feet, galvanized steel plate assembled.

Springing - The springing is made of 80 mm mechanically stretched strips, composed of nylon wires wound in a spiral.

Caractéristiques techniques

Structure - Réalisée avec des éléments porteurs en bois massif de sapin de différentes épaisseurs. Panneaux latéraux et éléments structuraux en bois de sapin stratifié de 18 mm, élément de remplissage en agglomérat de bois de 18 mm et 4 mm. Le tout traité au naturel en classe E1, soit à faible émission de formaldéhydes. Le cadre est entièrement recouvert de velours 100% polyamines couplé à chaud à 100% de résine expansée 100% polyéther et/ou ouate de 200 g 100% polyester.

Rembourrage - Coussin d'assise en mousse de polyuréthane souple et indéformable densité D35 SR revêtu en couche collée de 300 g 100% polyester. Coussin de dossier en mousse de polyuréthane souple et indéformable densité D18 moelleux, revêtu en couche collée de 300 g 100% polyester. Éléments de remplissages en mousse indéformable D21, DPK40, accoudoir en D30 indéformable revêtu de résine 200 g 100% polyester.

Les matériaux sont conformes aux normes européennes 91/156/etc Informations environnementales sur la protection: la nature périssable du produit, sur la base de sa composition, est pratiquement nulle. Les résines ne figurent pas dans la liste établie par la norme de classification des déchets de matériaux soumis à une surveillance particulière. Les résines expansées ne contiennent pas de fréon ni de solvants chlorés. Les résines expansées ne contiennent pas de substances nuisibles à la couche d'ozone et ne sont pas fabriquées avec des produits figurant dans le Protocole de Montréal et le Règlement (CE) n° 3093/94.

Appui-tête cylindrique et en forme de coussin totalement revêtus de tissu et fixés au cadre métallique

Pieds et accessoires - Pieds en chêne naturel, peint couleur tabac et gris à pore ouvert, assemblés en plaque d'acier galvanisée.

Suspension - La suspension est réalisée avec des bandes de 80 mm mécaniquement tendues, composées de fils de nylon enroulés en spirale.

Elementi fissi / Fixed units / Éléments fixes



Spessore bracciolo
Armrest thickness
Épaisseur accoudoir

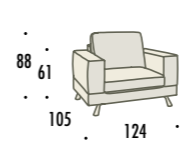

Art. 01
Poltrona Small
Armchair Small
Fauteuil Small

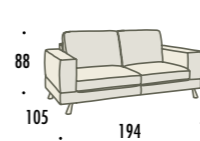

Art. 02
Divano 2 posti Small
2-seater sofa Small
Canapé 2 places Small

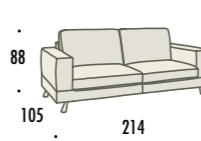

Art. 20
Divano 2 posti Midi
2-seater sofa Midi
Canapé 2 places Midi

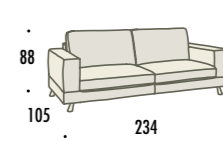

Art. 03
Divano 3 posti Large
3-seater sofa Large
Canapé 3 places Large

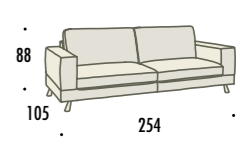

Art. 06
Divano 3 posti Big
3-seater sofa Big
Canapé 3 places Big

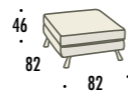

Art. 11
Pouf quadrato
Square pouf
Pouf carré

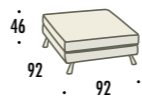

Art. 12
Pouf quadrato
Square pouf
Pouf carré

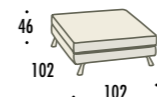

Art. 13
Pouf quadrato
Square pouf
Pouf carré

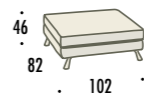

Art. 14
Pouf rettangolare
Rectangular pouf
Pouf rectangulaire

Elementi componibili / Modular units / Éléments composables

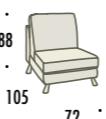

Art. 90
Elemento centrale Small
Central element Small
Chaufeuse Small

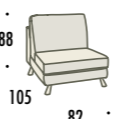

Art. 91
Elemento centrale Midi
Central element Midi
Chaufeuse Midi

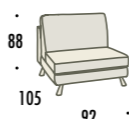

Art. 92
Elemento centrale Large
Central element Large
Chaufeuse Large

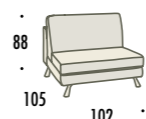

Art. 93
Elemento centrale Big
Central element Big
Chaufeuse Big

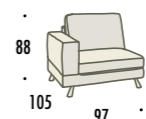

Art. dx SD - Art. sx SS
Laterale 1 posto Small DX-SX
RH-LH 1-seater side element Small
Canapé bâtarde 1 place Small D-G

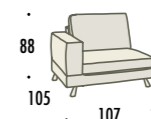

Art. dx MD - Art. sx MS
Laterale 1 posto Midi DX-SX
RH-LH 1-seater side element Midi
Canapé bâtarde 1 place Midi D-G

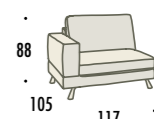

Art. dx LD - Art. sx LS
Laterale 1 posto Large DX-SX
RH-LH 1-seater side element Large
Canapé bâtarde 1 place Large D-G



Art. dx BD - Art. sx BS
Laterale 1 posto Big DX-SX
RH-LH 1-seater side element Big
Canapé bâtarde 1 place Big D-G

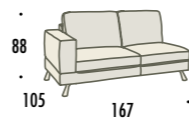

Art. dx 2D - Art. sx 2S
Laterale 2 posti Small DX-SX
RH-LH 2-seater side element Small
Canapé bâtarde 2 place Small D-G

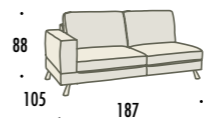

Art. dx GD - Art. sx GS
Laterale 2 posti Midi DX-SX
RH-LH 2-seater side element Midi
Canapé bâtarde 2 place Midi D-G



Art. dx 3D - Art. sx 3S
Laterale 3 posti Large DX-SX
RH-LH 3-seater side element Large
Canapé bâtarde 3 place Large D-G



Art. dx 6D - Art. sx 6S
Laterale 3 posti Big DX-SX
RH-LH 3-seater side element Big
Canapé bâtarde 3 place Big D-G

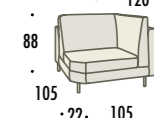

Art. AQ
Angolo quadro
Square corner
Angle carré

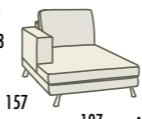

Art. dx CD - Art. sx CS
Chaise longue Midi DX-SX
RH-LH Chaise longue Midi
Mérienne Midi D-G



Art. dx CL - Art. sx LC
Chaise longue Large DX-SX
RH-LH Chaise longue Large
Mérienne Large D-G

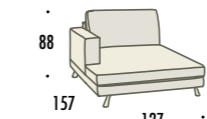

Art. dx CB - Art. sx BC
Chaise longue Big DX-SX
RH-LH Chaise longue Big
Mérienne Big D-G

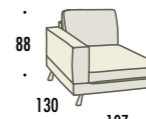

Art. dx IM - Art. sx MI
Elemento ad isola Midi DX-SX
RH-LH Deep seat element Midi
Élément assise plus Midi D-G

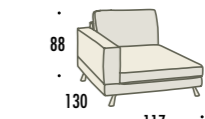

Art. dx IL - Art. sx LI
Elemento ad isola Large DX-SX
RH-LH Deep seat element Large
Élément assise plus Large D-G

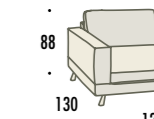

Art. dx IB - Art. sx BI
Elemento ad isola Big DX-SX
RH-LH Deep seat element Big
Élément assise plus Big D-G

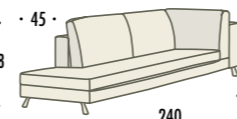

Art. dx TP - Art. sx PT
Terminale c/penisola Large DX-SX
RH-LH End element with peninsula Large
Terminal avec peninsula Large D-G

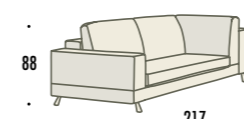

Art. dx LT - Art. sx TL
Laterale angolo Large DX-SX
RH-LH Corner side element Large
Latéral angle Large D-G

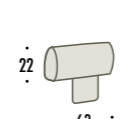

Art. 30
Poggiatesta saponetta
Soap-shaped headrest
Appuie-tête a forme de savon

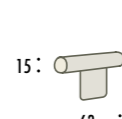

Art. 31
Poggiatesta cilindro
Cylinder-shaped headrest
Appuie-tête a forme de cylindre

Esempio composizione / Layout example / Exemple de composition

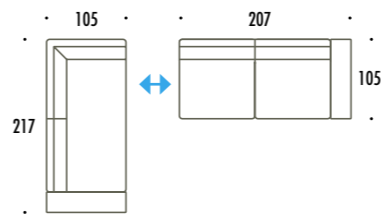

Art. dx LT - Art. sx TL + Art. dx 3D - Art. sx 3S
Laterale angolo Large DX-SX + Laterale 3 posti Large DX-SX
RH-LH Corner side element Large + RH-LH 3-seater side element Large
Latéral angle Large D-G+ Canapé bâtarde 3 place Large D-G

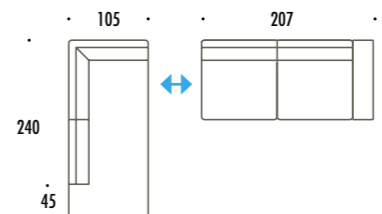

Art. dx TP - Art. sx PT + Art. dx 3D - Art. sx 3S
Terminale c/penisola Large DX-SX + Laterale 3 posti Large DX-SX
RH-LH End element with peninsula Large + RH-LH 3-seater side element Large
Terminal avec peninsula Large D-G+ Canapé bâtarde 3 place Large D-G

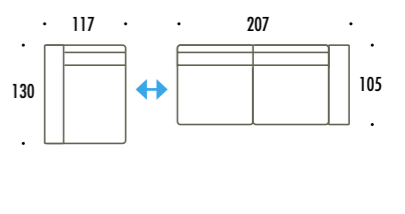

Art. dx IL - Art. sx LI + Art. dx 3D - Art. sx 3S
Elemento ad isola Large DX-SX + Laterale 3 posti Large DX-SX
RH-LH Deep seat element Large + RH-LH 3-seater side element Large
Élément assise plus Large D-G+ Canapé bâtarde 3 place Large D-G

Piede BAOBAB in legno H.14 / BAOBAB wooden feet H. 14 / Pied BAOBAB en bois H.14



Rovere Londra
Oak "Londra"
Chêne "Londra"



Rovere tabacco
Oak "tabacco"
Chêne "tabacco"



Rovere naturale
Oak "naturale"
Chêne "naturale"

Optional poggiatesta / Optional headrest / Option appui-tête





Newman

**Style contemporaneo
per interpretazioni differenti
e particolari sartoriali
molto distintivi.**

Contemporary style
for different interpretations
and tailoring details,
very distinctive.

Style contemporain
pour différentes interprétations
et détails couture particuliers
hautement distinctifs.





Newman



Per un comfort personalizzato le eleganti linee di design quotidiano, sono integrabili con poggiatesta e cuscini poggianti, per la zona bassa dello schienale.

For a customized comfort, the stylish everyday design lines, can be integrated with headrest and backrest cushions for the lower area of the back.

Pour un confort personnalisé, les élégantes lignes de design quotidien, peuvent accueillir des appuis-tête et des coussins lombaires destinés à la partie inférieure du dos.





Newman



Comodo e borghese. Ma insieme il gusto giovane per le citazioni vintage, per il tono naturale, i colori e il sapore eco chic degli ambienti.

Comfortable and middle-class. But with a young taste for the vintage references, the natural tones, colours and eco chic taste of the environments.

Confortable et bourgeois. Mais avec le jeune goût pour les citations d'époque, pour le ton naturel, les couleurs et la saveur éco-chic des espaces.



Poggiatesta coordinato e dalla forma avvolgente. A lato grande complemento imbottito coordinato: pouf/piano di appoggio/seduta, con profili e angoli a vista. Strettamente coordinato ma, insieme, di personalità particolare.

Coordinated headrest with a wrap-around shape. On the side, a large padded coordinated composition: ottoman/top/seat, with profiles and angles in view. Strictly coordinated but, together, with a peculiar personality.

Appui-tête coordonné à forme enveloppante. Sur le côté, un grand complément d'ameublement rembourré coordonné : pouf/plan d'appui/assise, avec montants et angles apparents. Rigoureusement coordonné tout en gardant une personnalité particulière.

Newman





Newman



Newman

Piccole vanità... l'angolo scoperto con il tessuto coordinato in tinta o a contrasto al cordoncino, evidenzia il particolare piedino a 45°. L'elegante bordura in tono più scuro decora la struttura intera... minimal ma très chic...



A little vanity... the uncovered corner, with the coordinated fabric in the same colour or in contrast with the lanyard, highlights the 45° foot. The elegant borders, matching but darker, decorate the internal structure... minimal but très chic...

Petit plus avec... l'angle découvert en tissu coordonné ou en contraste avec le cordon, pour souligner le pied en 45°. L'élégant passepoil ton sur ton plus sombre décore toute la structure... minimaliste mais très chic...

Newman



Newman

Completamente sfoderabile
Totally removable cover
Complètement déhoussable

Caratteristiche tecniche

Struttura - Realizzata con masselli portanti in legno massiccio di abete in vari spessori. Fianchi e parti strutturali in multistrato di abete da 18 mm, parti di tamponamento in agglomerato di legno di spessore 18mm e 4 mm. Il tutto trattato al naturale in classe E1, pertanto a bassa emissione di formaldeide. Il telaio è completamente rivestito con vellutino 100% poliammine termo accoppiato ad espanso 100% polietere e/o ovatta resinato da 200 gr di 100% poliestere.

Imbottitura - Cuscino seduta in poliuretano espanso flessibile e indeformabile in densità D30M rivestito in falda termolegata da 300 gr in fiocco di poliestere 100%. Cuscino schiena in poliuretano espanso flessibile e indeformabile in densità D16S, rivestito in falda termolegata da 300 gr in fiocco di poliestere 100%. Bracciolo e parti di tamponamento in lastre di poliuretano indeformabile in D40.

Poggiatesta a cilindro e a cuscinetto totalmente rivestiti in tessuto e fissati su telaio in metallo. **I materiali corrispondono alle normative europee 91/156/etc.**

Informazioni ambientali sulla sicurezza: la deperibilità del prodotto, secondo la sua composizione, è praticamente nulla. Le resine non sono contenute nella lista della normativa di classificazione dei rifiuti per materiali soggetti a particolare sorveglianza. Le resine espanso sono esenti da freon e solventi clorurati. Le resine espanso non contengono sostanze che danneggiano l'ozonofera e non vengono fabbricate con prodotti menzionati nel protocollo di Montreal e Regolamento (CE) n. 3093/94.

Piedini ed accessori - Piedini modello KOFI in metallo, taglio laser, finitura "carbon look".

Molleggio - Il molleggio è realizzato in nastri da 80 mm tesi meccanicamente, composta da fili di nylon avvolto a spirale.

Technical characteristics

Structure - Made with bearing parts in solid fir wood in various thicknesses. 18mm fir plywood sides and structural parts, 18mm and 4 mm thick particle wood infill parts. All treated naturally in Class E1, thus with low formaldehyde emissions. The frame is completely covered with 100% polyamines velvetten thermo-coupled with 100% polyether foam and/or 200 g. 100% polyester wadding resin.

Padding - Flexible and non-deformable polyurethane foam seat cushion, density D30M, coated with 300 gr layer-bonded 100% polyester staple. Flexible and non-deformable polyurethane foam back cushion, density D16S, coated with 300 gr layer-bonded 100% polyester staple. Armrest and structural parts made of D40 polyurethane foam sheets.

Cylinder and pad headrest completely coated with fabric and fixed on a metal frame. **The materials meet the European standards 91/156/etc.**

Environmental information on safety: The perishable nature of the product, according to its composition, is practically nil. Resins are not included in the list of standards for the classification of waste materials subject to special surveillance. Resin foams are free from freon and chlorinated solvents. Resin foams do not contain substances that damage the ozone layer and are not manufactured with products mentioned in the Montreal Protocol and (CE) Regulation no. 3093/94.

Feet and accessories - metal KOFI feet, laser cutting, "carbon look" finish.

Springing - The springing is made of 80 mm mechanically stretched strips, composed of nylon wires wound in a spiral.

Caractéristiques techniques

Structure - Réalisée avec des éléments porteurs en bois massif de sapin de différentes épaisseurs. Panneaux latéraux et éléments structuraux en bois de sapin stratifié de 18 mm, élément de remplissage en agglomérat de bois de 18 mm et 4 mm. Le tout traité au naturel en classe E1, soit à faible émission de formaldéhydes. Le cadre est entièrement recouvert de velours 100% polyamines couplé à chaud avec de la résine expansée 100% polyéther et/ou ouate de 200 g 100% polyester.

Rembourrage - Coussin d'assise en mousse de polyuréthane souple et indéformable densité D30M revêtu en couche collée de 300 g en flocons 100% polyester Coussin d'assise en mousse de polyuréthane souple et indéformable densité D16S revêtu en couche collée de 300 g en flocons 100% polyester Accouider et éléments de remplissage en plaques de polyuréthane indéformable en D40.

Appui-tête cylindrique et en forme de coussin totalement revêtus de tissu et fixés au cadre métallique. **Les matériaux sont conformes aux normes européennes 91/156/etc.**

Informations environnementales sur la sécurité: la nature périssable du produit, sur la base de sa composition, est pratiquement nulle. Les résines ne figurent pas dans la liste établie par la norme de classification des déchets de matériaux soumis à une surveillance particulière. Les résines expansées ne contiennent pas de fréon ni de solvants chlorés. Les résines expansées ne contiennent pas de substances nuisibles à la couche d'ozone et ne sont pas fabriquées avec des produits figurant dans le Protocole de Montréal et le Règlement (CE) n° 3093/94.

Pieds et accessoires - Pieds modèle KOFI en métal, découpe laser, finitions «carbon look».

Suspension - La suspension est réalisée avec des bandes de 80 mm mécaniquement tendues, composées de fils de nylon enroulés en spirale.

Optional cuscino poggiareni / Optional back cushion / En option coussin lombaire



Optional poggiatesta / Optional headrest / Option appui-tête



Elementi fissi / Fixed units / Éléments fixes

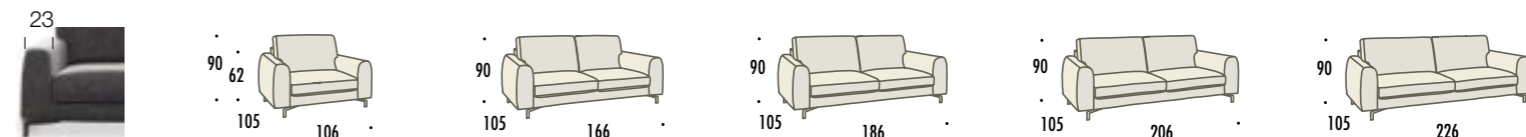

Spessore bracciolo
Armrest thickness
Épaisseur accouider

Art. 01
Poltrona Small
Armchair Small
Fauteuil Small

Art. 02
Divano 2 posti Small
2-seater sofa Small
Canapé 2 places Small

Art. 20
Divano 2 posti Midi
2-seater sofa Midi
Canapé 2 places Midi

Art. 03
Divano 3 posti Large
3-seater sofa Large
Canapé 3 places large

Art. 06
Divano 3 posti Big
3-seater sofa Big
Canapé 3 places Big



Art. 07
Divano 3 posti Maxi
3-seater sofa Maxi
Canapé 3 places Maxi

Art. 12
Pouf quadrato
Square pouf
Pouf carré

Art. 13
Pouf rettangolare
Rectangular pouf
Pouf rectangulaire

Elementi componibili / Modular units / Éléments composables

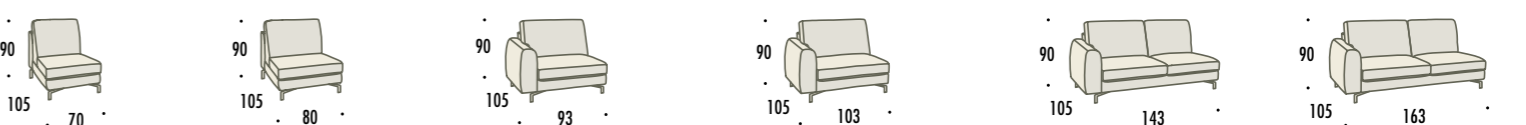

Art. 90
Elemento centrale Midi
Central element Midi
Chausseuse Midi

Art. 91
Elemento centrale Large
Central element Large
Chausseuse Large

Art. dx MD - Art. sx MS
Laterale 1 posto Midi DX-SX
RH-LH 1-seater side element Midi
Canapé bâtarde 1 place Midi D-G

Art. dx LD - Art. sx LS
Laterale 1 posto Large DX-SX
RH-LH 1-seater side element Large
Canapé bâtarde 1 place Large D-G

Art. dx 2D - Art. sx 2S
Laterale 2 posti Small DX-SX
RH-LH 2-seater side element Small
Canapé bâtarde 2 place Small D-G

Art. dx GD - Art. sx GS
Laterale 2 posti Midi DX-SX
RH-LH 2-seater side element Midi
Canapé bâtarde 2 place Midi D-G



Art. dx 3D - Art. sx 3S
Laterale 3 posti Large DX-SX
RH-LH 3-seater side element Large
Canapé bâtarde 3 place Large D-G

Art. dx 6D - Art. sx 6S
Laterale 3 posti Big DX-SX
RH-LH 3-seater side element Big
Canapé bâtarde 3 place Big D-G

Art. AQ
Angolo quadro
Square corner
Angle carré

Art. dx CD - Art. sx CS
Chaise longue Midi DX-SX
RH-LH Chaise longue Midi
Méristenne Midi D-G

Art. dx CL - Art. sx LC
Chaise longue Large DX-SX
RH-LH Chaise longue Large
Méristenne Large D-G



Art. dx TP - Art. sx PT
Terminale c/penisola Large DX-SX
RH-LH End element with peninsula Large
Terminal avec péninsule Large D-G

Art. dx LT - Art. sx TL
Laterale angolo Large DX-SX
RH-LH Corner side element Large
Latéral angle Large D-G

Art. 31
Poggiatesta cilindro
Cylinder-shaped headrest
Appui-tête a forme de cylindre

Poggiareni
Support for the lumbar area
Cale-reins

Esempio composizione / Layout example / Exemple de composition

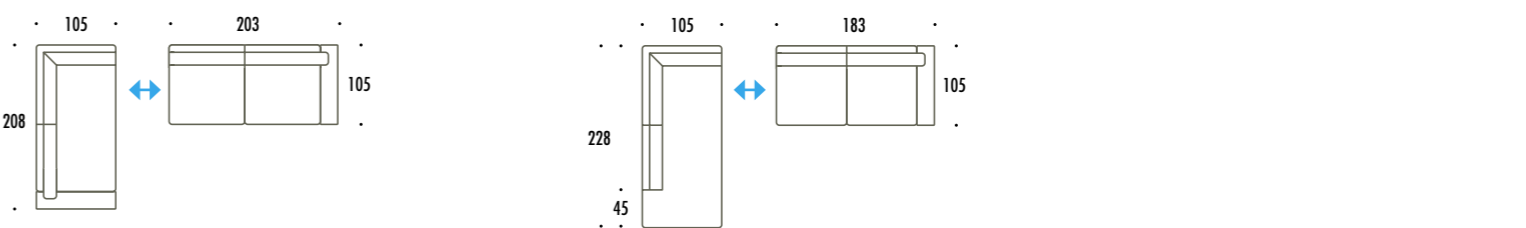

Art. dx LT - Art. sx TL + Art. dx 6D - Art. sx 6S
Laterale angolo Large DX-SX + Laterale 3 posti Big DX-SX
RH-LH Corner side element Large + RH-LH 3-seater side element Big
Latéral angle Large D-G + Canapé bâtarde 3 place Big D-G

Art. dx TP - Art. sx PT + Art. dx 3D - Art. sx 3S
Terminale c/penisola Large DX-SX + Laterale 3 posti Large DX-SX
RH-LH End element with peninsula Large + RH-LH 3-seater side element Large
Terminal avec péninsule Large D-G + Canapé bâtarde 3 place Large D-G

Piede KOFI in metallo H. 13 / KOFI metal foot H. 13 / Pied KOFI en métal H. 13



Carbon look lucido
Shining Carbon look
Carbon look brillant

Optional angolo in tessuto e cordoncino coordinato o a contrasto / Optional fabric corner with matching or contrasting border / En option angle en tissu et cordon coordonné ou en contrasten appui-tête



A contrasto / Contrasting colour / En contraste



In tinta / Plain colour / Ton sur ton



Paul

Accogliente nelle linee dei braccioli arrotondate nel lato interno, fino all'appoggio degli schienali ampi. Effetto trapuntato particolare a evidenziare la struttura portante.

Cozy lines of the rounded armrests on the inner side, up to the support of the wide backrests. Quilted effect to highlight the bearing structure.

Lignes chaleureuses des accoudoirs arrondis vers l'intérieur, jusqu'au support des larges dossiers. Effet matelassé particulier pour souligner la structure porteuse.





Paul

Interessante abbinamento tra lavorazioni diverse dello stesso tessuto. Il confine tracciato dal bordo in evidenza in tinta o a contrasto.

Interesting combinations of different kinds of processing of the same fabric. The visible border matching or contrasting.

Association intéressante entre les différents traitements du même tissu. La frontière tracée par la bordure est mise en évidence ton sur ton ou en contraste.



Paul

Completamente sfoderabile
Totally removable cover
Complètement déhoussable

Caratteristiche tecniche

Struttura - Realizzata con masselli portanti in legno massiccio di abete in vari spessori. Fianchi e parti strutturali in multistrato di abete da 18 mm, parti di tamponamento in agglomerato di legno di spessore 18mm e 4 mm. Il tutto trattato al naturale in classe E1, pertanto a bassa emissione di formaldeide. Il telaio è completamente rivestito con vellutino 100% poliammine termo accoppiato ad espanso 100% polietere e/o ovatta resinato da 200 gr di 100% poliestere.

Imbottitura - Cuscino seduta in poliuretano espanso flessibile e indeformabile in densità D30M rivestito in falda termolegata da 300 gr in fiocco di poliestere 100%. Cuscino schiena in poliuretano espanso flessibile e indeformabile in densità D16S, rivestito in falda termolegata da 300 gr in fiocco di poliestere 100%. Bracciolo e parti di tamponamento in lastre di poliuretano indeformabile in D40. Poggiatesta: a cilindro e a cuscinetto totalmente rivestiti in tessuto e fissati su telaio in metallo. **I materiali corrispondono alle normative europee 91/156/ etc. Informazioni ambientali sulla sicurezza:** la deperibilità del prodotto, secondo la sua composizione, è praticamente nulla. Le resine non sono contenute nella lista della normativa di classificazione dei rifiuti per materiali soggetti a particolare sorveglianza. Le resine espanso sono esenti da freon e solventi clorurati. Le resine espanso non contengono sostanze che danneggiano l'ozonofera e non vengono fabbricate con prodotti menzionati nel protocollo di Montreal e Regolamento (CE) n. 3093/94.

Piedini ed accessori - Piedini modello KOFI in metallo, taglio laser, finitura "carbon look".

Molleggio - Il molleggio è realizzato in nastri da 80 mm tesi meccanicamente, composta da fili di nylon avvolto a spirale.

Technical characteristics

Structure - Made with bearing parts in solid fir wood in various thicknesses. 18mm fir plywood sides and structural parts, 18mm and 4 mm thick particle wood infill parts. All treated naturally in Class E1, thus with low formaldehyde emissions. The frame is completely covered with 100% polyamines velvetten thermo-coupled with 100% polyether foam and/or 200 g. 100% polyester wadding resin.

Padding - Flexible and non-deformable polyurethane foam seat cushion, density D30M, coated with 300 gr layer-bonded 100% polyester staple. Flexible and non-deformable polyurethane foam back cushion, density D16S, coated with 300 gr layer-bonded 100% polyester staple. Armrest and structural parts made of D40 polyurethane foam sheets. Cylinder and pad headrest completely coated with fabric and fixed on a metal frame. **The materials meet the European standards 91/156/etc. Environmental information on safety:** The perishable nature of the product, according to its composition, is practically nil. Resins are not included in the list of standards for the classification of waste materials subject to special surveillance. Resin foams are free from freon and chlorinated solvents. Resin foams do not contain substances that damage the ozone layer and are not manufactured with products mentioned in the Montreal Protocol and (CE) Regulation no. 3093/94.

Feet and accessories - metal KOFI feet, laser cutting, "carbon look" finish.

Springing - The springing is made of 80 mm mechanically stretched strips, composed of nylon wires wound in a spiral.

Caractéristiques techniques

Structure - Réalisée avec des éléments porteurs en bois massif de sapin de différentes épaisseurs. Panneaux latéraux et éléments structuraux en bois de sapin stratifié de 18 mm, élément de remplissage en agglomérat de bois de 18 mm et 4 mm. Le tout traité au naturel en classe E1, soit à faible émission de formaldéhydes. Le cadre est entièrement recouvert de velours 100% polyamines couplé à chaud à 100% de résine expansée 100% polyéther et/ou ouate de 200 g 100% polyester.

Rembourrage - Coussin d'assise en mousse de polyuréthane souple et indéformable densité D30M revêtu en couche collée de 300 g en flocons 100% polyester Coussin d'assise en mousse de polyuréthane souple et indéformable densité D16S revêtu en couche collée de 300 g en flocons 100% polyester Accoudoir et éléments de remplissage en plaques de polyuréthane indéformable en D40. Appui-tête : cylindrique et en forme de coussin totalement revêtus de tissu et fixés au cadre métallique **Les matériaux sont conformes aux normes européennes 91/156/etc. Informations environnementales sur la protection:** la nature périssable du produit, sur la base de sa composition, est pratiquement nulle. Les résines ne figurent pas dans la liste établie par la norme de classification des déchets de matériaux soumis à une surveillance particulière. Les résines expansées ne contiennent pas de fréon ni de solvants chlorés. Les résines expansées ne contiennent pas de substances nuisibles à la couche d'ozone et ne sont pas fabriquées avec des produits figurant dans le Protocole de Montréal et le Règlement (CE) n° 3093/94.

Pieds et accessoires - Pieds modèle KOFI en métal, découpe laser, finitions « carbon look ».

Suspension - La suspension est réalisée avec des bandes de 80 mm mécaniquement tendues, composées de fils de nylon enroulés en spirale.

Piede KOFI in metallo H. 13 / KOFI metal foot H. 13 / Pied KOFI en métal H. 13



Carbon look lucido
Shining Carbon look
Carbon look brillant

Optional bordo a contrasto / Optional contrasting border / En option bordure en contraste



Optional cuscino poggiaresi / Optional back cushion / En option coussin lombaire

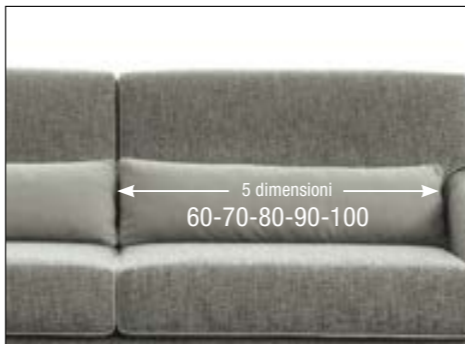

Optional poggiatesta / Optional headrest / Option appui-tête



Elementi fissi / Fixed units / Éléments fixes

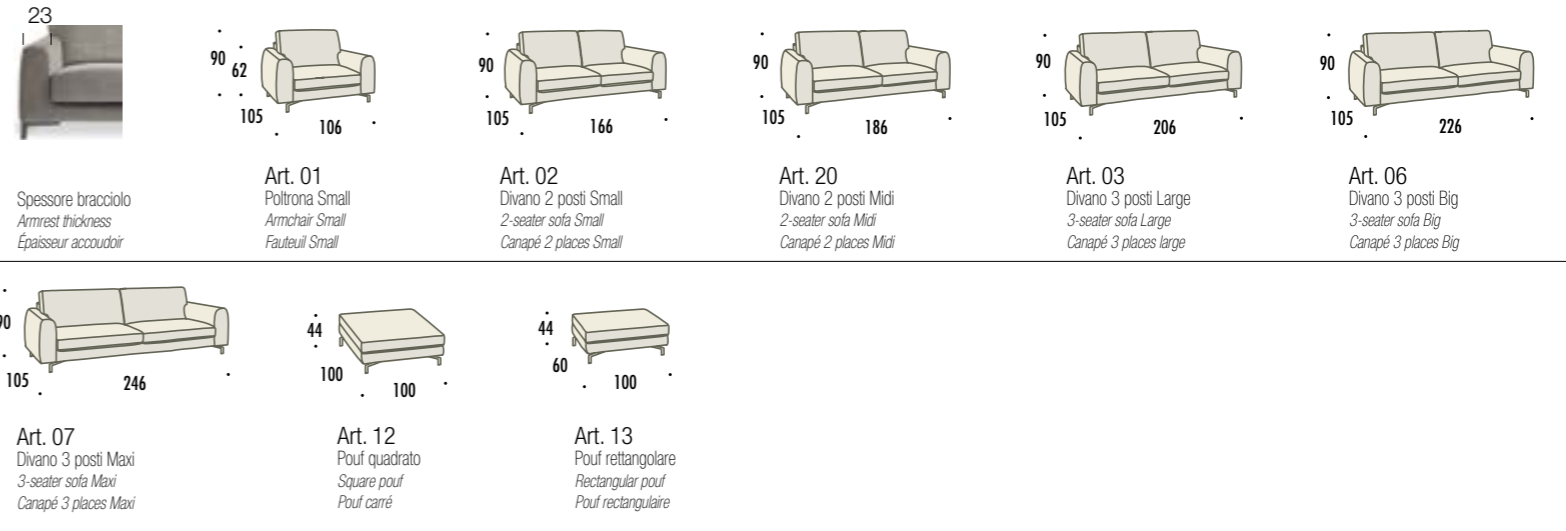

Elementi componibili / Modular units / Éléments composables

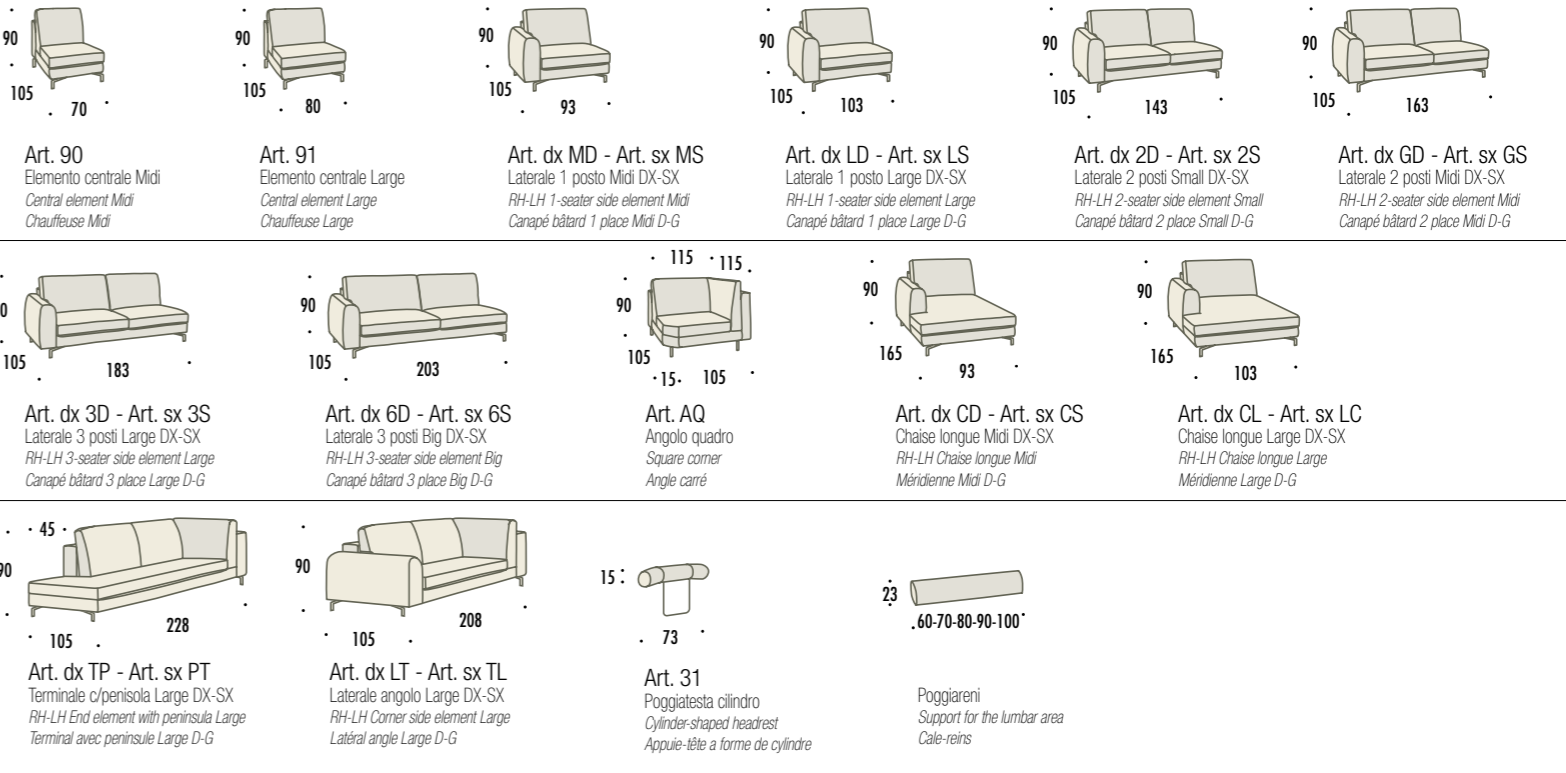

Esempio composizione / Layout example / Exemple de composition

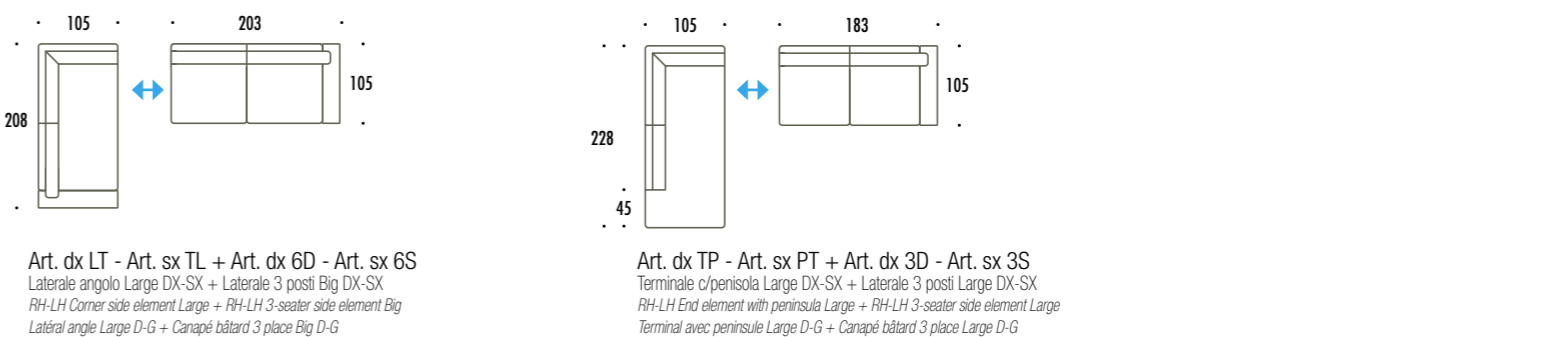

Poufs & Tables

Per completare l'arredo dello spazio living una gamma ricca e completa di eleganti complementi coordinati: tavolini, pouf, piani d'appoggio imbottiti...

To complete the decor of the living area, a rich and comprehensive range of stylish matching accessories: tables, ottomans, padded tops...

Une gamme riche et complète d'accessoires élégants coordonnés vient compléter la décoration de l'espace de vie: tables, poufs, plans d'appui rembourrés...



Flamingo

collection

Collezione di tavolini importanti, stabili, eleganti in due proposte di marmo, e in forme diverse per il piano. Diverse altezze e quattro finiture diverse per i particolari piedini: cromo, oro, rame, carbon look, per interpretare ogni stile.

A collection of important tables, stable, elegant in two marble proposals with different shapes for the top. Different heights and four different finishes for feet details: chrome, gold, copper, carbon look, to interpret every style.

Collection de tables basses imposantes, stables, élégantes en deux propositions de marbre, avec différentes formes de plateaux. Hauteurs différentes avec quatre finitions possibles pour les pieds: chrome, or, cuivre, carbon look, pour interpréter tous les styles.



Flamingo collection

Caratteristiche tecniche

Dati Tecnici

Emperador Dark
 - Peso volumetrico 2,720 Kg/m3
 - Resistenza a compressione 1126 Kg/cm2
 - Resistenza a flessione 106 Kg/cm2
 - Resistenza ad abrasione 0,55 mm
 - Imbibizione 0,31 % per peso
 Carrara
 - Peso volumetrico 2742 Kg/m3
 - Resistenza a compressione 1298 Kg/cm2
 - Resistenza a flessione 207 Kg/cm2
 - Resistenza ad abrasione 0,64 mm
 - Imbibizione 0,15 % per peso
 - Coeff. di dilatazione termica 0,0073 mm./m.

Consigli per la manutenzione

Come pulire un ripiano in marmo - Per pulire un ripiano in marmo utilizzate prima di tutto un panno morbido per rimuovere la polvere. Se non sono presenti particolari macchie, vi basterà passare le superfici da pulire con un panno in microfibra inumidito d'acqua tiepida, che vi aiuterà ad eliminare eventuali tracce di sporco. In caso di macchie o di residui da eliminare, utilizzate una spugnetta morbida dopo averla insaponata con qualche goccia di sapone liquido ecologico o con una saponetta naturale (mai utilizzare sul marmo prodotti per la pulizia dal pH acido).

Le sostanze e i prodotti da evitare - Per la pulizia del marmo dovete evitare tutte le sostanze acide che invece possono risultare utili per le pulizie ecologiche di altre parti della casa. Per il marmo non dovete utilizzare succo di limone, acido citrico, aceto di vino o aceto di mele, detersivi aggressivi ed altre soluzioni che risultino acide o corrosive, dato che il marmo è molto delicato. Evitate i prodotti abrasivi e tutti gli strumenti che potrebbero graffiare il marmo e rovinarlo in modo irrimediabile.

Technical characteristics

Technical Data

Emperador Dark
 - Bulk density 2,720 Kg/m3
 - Compressive strength 1126 Kg/cm2
 - Flexural strength 106 Kg/cm2
 - Abrasion resistance 0.55 mm
 - Absorption 0.31 % per weight
 Carrara
 - Bulk density 2742 Kg/m3
 - Compressive strength 1298 Kg/cm2
 - Flexural strength 207 Kg/cm2
 - Abrasion resistance 0.64 mm
 - Absorption 0.15 % per weight
 - Thermal expansion coefficient 0.0073 mm./m.

Instructions for maintenance

How to clean a marble top - To clean a marble top, first use a soft cloth to remove dust. If there are no special stains, the surfaces can be cleaned with a microfiber cloth dampened with warm water, which will help remove any dirt. In case of stains or residues, use a soft sponge after having soapy with a few drops of ecological liquid soap or natural soap (never use detergents with acid pH on marble products).

Substances and the products to avoid - When cleaning marble, avoid acidic substances, which, on the other hand, may be useful for the ecological cleaning of other parts of the house. Lemon juice, citric acid, vinegar or apple cider vinegar, strong detergents and other solutions that are acidic or corrosive should never be used with marble, because it is very delicate. Avoid abrasive cleaners and tools that could scratch the marble and ruin it beyond repair.

Caractéristiques techniques

Données techniques

Emperador Dark
 - Poids volumétrique 2,720 Kg/m3
 - Résistance à la compression 1126 Kg/cm2
 - Résistance à la flexion 106 Kg/cm2
 - Résistance à l'abrasion 0,55 mm
 - Absorption 0,31 % par poids
 Carrara
 - Poids volumétrique 2742 Kg/m3
 - Résistance à la compression 1298 Kg/cm2
 - Résistance à la flexion 207 Kg/cm2
 - Résistance à l'abrasion 0,64 mm
 - Absorption 0,15 % par poids
 - Coeff. de dilatation thermique 0,0073 mm./m.

Conseils d'entretien

Comment nettoyer une étagère en marbre - Pour nettoyer une étagère en marbre, utiliser tout d'abord un chiffon doux pour retirer la poussière. En absence de taches particulières, passer simplement un chiffon en microfibre humidifié avec de l'eau chaude sur la surface afin d'éliminer les éventuelles traces de saleté. En présence de taches ou de résidus à éliminer, utiliser une éponge douce imbibée de quelque goutte de savon liquide écologique ou de savon de savonnerie naturelle (ne jamais utiliser de produits à pH acide sur le marbre).

Substances et produits à éviter - Pour nettoyer le marbre, toujours éviter les substances acides lesquelles peuvent cependant être utilisées pour le nettoyage écologique d'autres parties de la maison. Pour le marbre, ne pas utiliser de jus de citron, acide citrique, vinaigre de vin ou de pomme, détergents agressifs et autres solutions acides ou corrosives, car le marbre est très délicat. Éviter les produits abrasifs et tous les outils susceptibles de rayer le marbre ou de l'abimer de façon irrémédiable.

Tavolini / Coffee tables / Tables basses

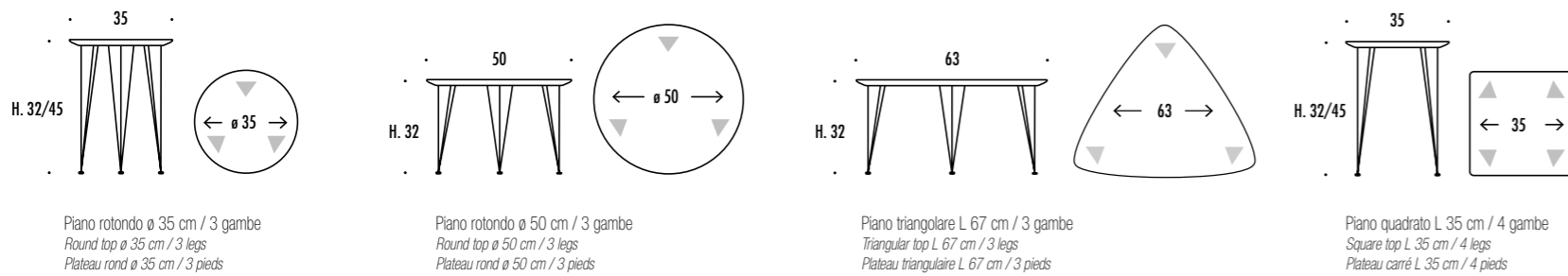

Finiture piano / Top finishes / Finitions plateau

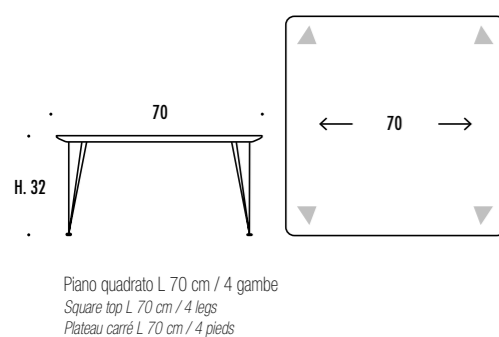

Finiture gambe / Leg finishes / Finitions pieds

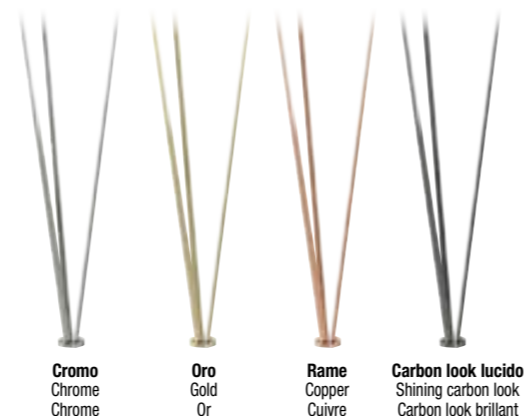



Pills

collection

**Personalizzabili a piacere...
la libertà di scegliere...
Tante forme, tondi, quadri,
rettangolari, ellissoidali...
Tre diverse altezze per le sedute
imbottite... Quattro finiture per
gli abbinamenti con i piedini di
sostegno.**

Customisable as desired... the freedom to choose...
Many shapes, round, square, rectangular, elliptical...
Three different heights for upholstered chairs... Four
finish combinations for the feet.

Personnalisables à souhait... la liberté de choisir... De
nombreuses formes, rondes, carrées, rectangulaires,
ellipsoïdales...
Trois hauteurs différentes pour les sièges rembourrés...
Quatre finitions pour les combinaisons avec pieds de
support.



Pills collection

Caratteristiche tecniche

Struttura - Pannello in multistrato di pino e/o abete e/o pioppo da 25 mm con predisposizione bossolo per l'applicazione di piedi in metallo.

Il tutto trattato al naturale in classe E1, pertanto a bassa emissione di formaldeide. Il telaio è completamente rivestito con vellutino 100% poliammine termoaccoppiato a ovatta resinata da 200 gr di 100% poliestere

Imbottitura

Seduta: lastra in poliuretano espanso flessibile e indeformabile in densità D30TL fresato tondo sul perimetro, totalmente rivestito in vellutino in poliammine 100% accoppiato a falda di resinato in poliestere da 200 gr. I materiali corrispondono alle normative europee 91/156/etc. Informazioni ambientali sulla sicurezza: la deperibilità del prodotto, secondo la sua composizione, è praticamente nulla. Le resine non sono contenute nella lista della normativa di classificazione dei rifiuti per materiali soggetti a particolare sorveglianza. Le resine espansive sono esenti da freon e solventi clorurati. Le resine espansive non contengono sostanze che danneggiano l'ozonofera e non vengono fabbricate con prodotti menzionati nel protocollo di Montreal e Regolamento (CE) n. 3093/94

Piedini - Piedini in metallo saldati e levigati a mano disponibili in quattro diverse finiture a bagno di galvanica.

Technical characteristics

Structure - Panel made of pine and/or fir plywood and/or 25 mm poplar with possible application of metal feet.

All treated naturally in Class E1, thus with low formaldehyde emissions. The frame is completely covered with 100% polyamines velveteen thermo-coupled with 200 g. 100% polyester wadding resin.

Padding

Seat: sheet of flexible and non-deformable polyurethane foam, D30TL, milled around the perimeter, completely covered with 100% polyamine velvet coupled with a layer of 200g polyester resin. The materials meet the European standards 91/156/etc. Environmental information on safety: The perishable nature of the product, according



Completamente sfoderabile / Totally removable cover / Complètement déhoussable

Pouf rotondi / Round ottomans / Poufs arrondis

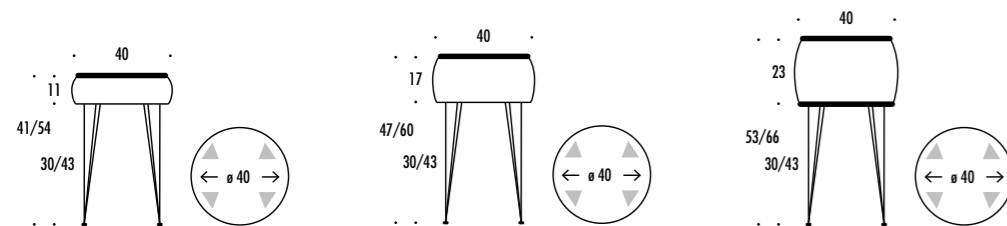

Piano rotondo ø 40 cm / 3 gambe
Round top ø 40 cm / 3 legs
Plateau rond ø 40 cm / 3 pieds

Piano rotondo ø 40 cm / 3 gambe
Round top ø 40 cm / 3 legs
Plateau rond ø 40 cm / 3 pieds

Piano rotondo ø 40 cm / 3 gambe
Round top ø 40 cm / 3 legs
Plateau rond ø 40 cm / 3 pieds

Finiture gambe / Leg finishes / Finitions pieds

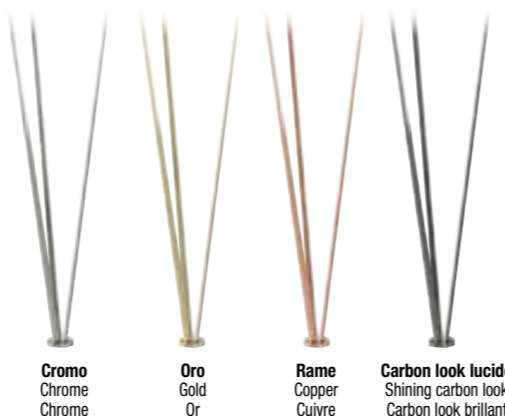

to its composition, is practically nil. Resins are not included in the list of standards for the classification of waste materials subject to special surveillance. Resin foams are free from freon and chlorinated solvents. Resin foams do not contain substances that damage the ozone layer and are not manufactured with products mentioned in the Montreal Protocol and (CE) Regulation no. 3093/94

Feet - Welded and hand polished metal feet, available in four different electroplated finishes.

Caractéristiques techniques

Structure - Panneau stratifié en pin et/ou sapin et/ou peuplier de 25 mm avec prédisposition pour l'application des pieds en métal.

Le tout traité au naturel en classe E1, soit à faible émission de formaldéhydes. Le cadre est entièrement recouvert de velours 100% polyamines couplé à chaud à une couche de résine de polyester de 200 g. Les matériaux sont conformes aux normes européennes 91/156/etc. Informations environnementales sur la protection : la nature périssable du produit, sur la base de sa composition, est pratiquement nulle. Les résines ne figurent pas dans la liste établie par la norme de classification des déchets de matériaux soumis à une surveillance particulière. Les résines expansées ne contiennent pas de freon ni de solvants chlorés. Les résines expansées ne contiennent pas de substances nuisibles à la couche d'ozone et ne sont pas fabriquées avec des produits figurant dans le Protocole de Montréal et le Règlement (CE) n° 3093/94

Rembourrage

Siège: plaque en mousse de polyuréthane souple et indéformable densité D30TL fraisée ronde sur le pourtour et totalement recouverte de velours 100% polyamines couplé à chaud à une couche de résine de polyester de 200 g. Les matériaux sont conformes aux normes européennes 91/156/etc. Informations environnementales sur la protection : la nature périssable du produit, sur la base de sa composition, est pratiquement nulle. Les résines ne figurent pas dans la liste établie par la norme de classification des déchets de matériaux soumis à une surveillance particulière. Les résines expansées ne contiennent pas de freon ni de solvants chlorés. Les résines expansées ne contiennent pas de substances nuisibles à la couche d'ozone et ne sont pas fabriquées avec des produits figurant dans le Protocole de Montréal et le Règlement (CE) n° 3093/94

Pieds - Pieds en métal soudés et polis à la main disponibles en quatre finitions galvanisées.



Completamente sfoderabile / Totally removable cover / Complètement déhoussable

Pouf quadrati / Square ottomans / Poufs carrés

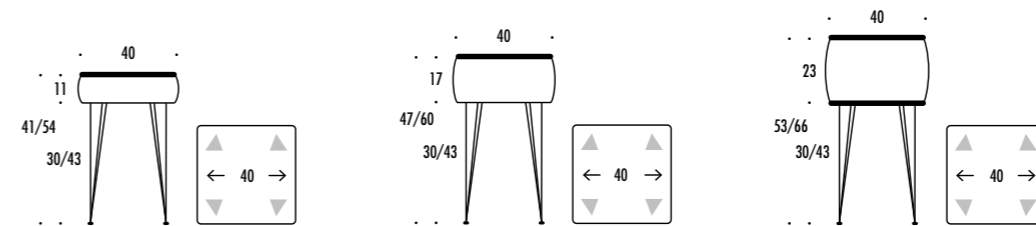

Piano quadrato L 40 cm / 4 gambe
Square top L 40 cm / 4 legs
Plateau carré L 40 cm / 4 pieds

Piano quadrato L 40 cm / 4 gambe
Square top L 40 cm / 4 legs
Plateau carré L 40 cm / 4 pieds

Piano quadrato L 40 cm / 4 gambe
Square top L 40 cm / 4 legs
Plateau carré L 40 cm / 4 pieds

Finiture gambe / Leg finishes / Finitions pieds

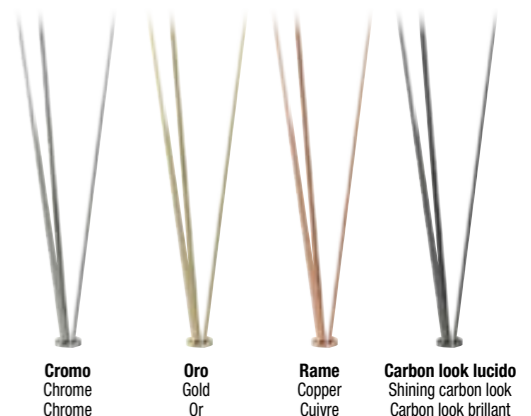

Pills collection



Completamente sfoderabile / Totally removable cover / Complètement déhoussable

Pouf / Ottoman / Pouf

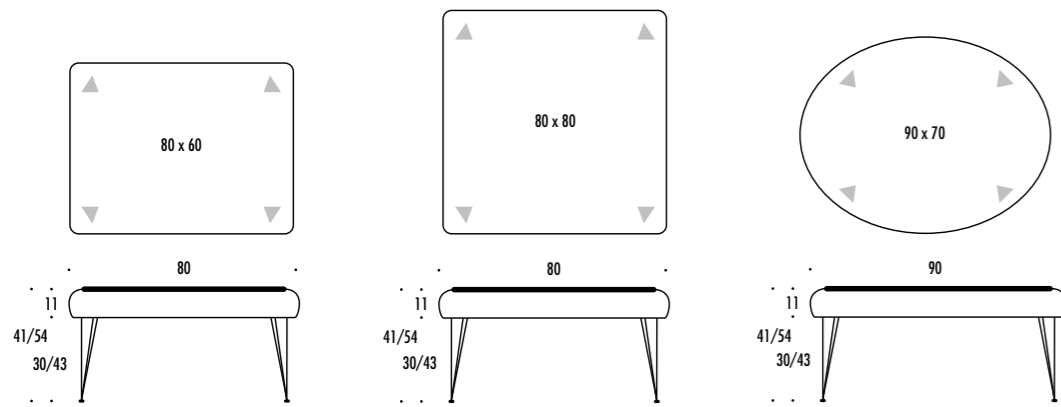

Piano rettangolare 80 x 60 cm / 4 gambe
Rectangular top 80 x 60 cm / 4 legs
Plan rectangulaire 80 x 60 cm / 4 pieds

Piano quadrato 80 x 80 cm / 4 gambe
Square top 80 x 80 cm / 4 legs
Plateau carré 80 x 80 cm / 4 pieds

Piano ovale 90 x 70 cm / 4 gambe
Oval top 90 x 70 cm / 4 legs
Plan ovale 90 x 70 cm / 4 pieds

Finiture gambe / Leg finishes / Finitions pieds



Zeppelin

Tecnologia, comodità e relax. La libertà e la comodità di essere sempre “carico” e connesso... Di ascoltare la tua musica preferita nel living... in camera... con un impianto stereo mobile (due casse e subwoofer) posizionabile a piacere, controllato da una dock station di ultima generazione...

Technology, comfort and relaxation. The freedom and comfort to always be «charged» and connected... To listen to your favourite music in the living room or in the bedroom with a mobile stereo system (two speakers and a subwoofer) positioned at will controlled by a docking station of the latest generation...

Technologie, confort et détente. La liberté et le confort d'être toujours «chargé» et connecté... Pour écouter votre musique préférée dans le salon ou dans votre chambre avec un système stéréo mobile (deux enceintes et un caisson de basses) à positionner où vous voulez et commandé par une centrale dernière génération...



Zeppelin

Caratteristiche tecniche

Tutti i comandi a sfioramento touch. Ascoltare la musica preferita, web radio o podcast, predisporre la radiosveglia, ricaricare in qualunque ambiente della casa. Nella dock station l'aggancio è predisposto per l'iPhone 5/6 e l'iPod o qualunque altro dispositivo che può essere collegato tramite Bluetooth o tramite porta usb. Disponibile anche lettore sd-card oltre all'uscita aux.

Struttura - Telaio in legno di abete da 18/25 mm, parti di tamponamento in fibra di legno naturale e in compensato. Il tutto in classe E1, pertanto a bassa emissione di formaldeide.

Rivestimento in espanso di poliestere accoppiato a caldo a vellutino aggrappante in poliestere e/o ovatta di poliestere al 100% da 200gr.

Imbottitura - Lastra in espanso indeformabile in densità 30 rivestito con resinato da 200 gr.

Piede in ABS H.20 mm.

Technical characteristics

All touch controls. Enjoy your favourite music, web radio or podcast, set the radio alarm, recharge in any room of the house. In the Dock Station, the socket fits the iPhone 5/6 and the iPod, or any other device that can be connected via Bluetooth or via the USB port. Also available sd-card reader and aux output.

Structure - 18/25 mm thick fir wood frame with natural wood fibre and plywood reinforcing parts. All in Class E1, thus with low formaldehyde emissions.

Coating made of hot-coupled to polyester foam with polyester velveteen and/or 100% polyester wadding, 200g.

Padding - Polyurethane foam, density 30, coated with 200g resin.

ABS Foot, H.20 mm.

Caractéristiques techniques

Toutes les commandes sont tactiles. Écouter votre musique préférée, la radio sur internet ou des podcasts, régler votre réveil, recharger vos dispositifs mobiles n'importe où chez vous. La centrale est prédisposée pour accueillir un iPhone 5/6 et un iPod, ou tout autre dispositif pouvant être connecté via Bluetooth ou port USB. Un lecteur de carte SD et une sortie AUX sont également prévus.

Structure - Structure en bois de sapin de 18/25 mm, éléments de remplissage en fibre de bois naturel et contreplaqué. Le tout classe E1, soit à faible émission de formaldéhydes.

Revêtement en mousse de polyester couplé à chaud avec velours en polyester et/ou ouate de polyester 100% de 200 g.

Rembourrage - Plaque de mousse indéformable densité 30 revêtue d'une résine de 200 g.

Pied en ABS H. 20 mm.



*
iPhone
connection

*
bluetooth
system

*
touch
system



*
Dock
station



*

I dispositivi collegati vengono anche ricaricati

Connected devices are also charged

Les appareils connectés sont également rechargés

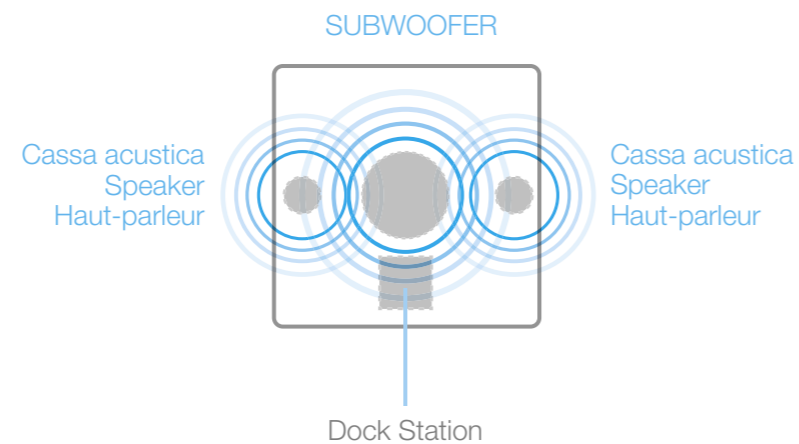

Zeppelin può essere personalizzato con il bordino in tinta coordinata o a contrasto

Zeppelin can be personalised with piped trim in contrasting or coordinated colour

Zeppelin peut être personnalisé avec le passepoil ton sur ton ou en contraste

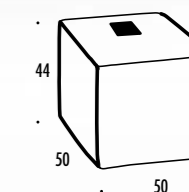

Piano quadrato 50 x 50 cm
Square top 50 x 50 cm
Piano quadrato 50 x 50 cm



Fuji

Simpatici imbottiti dalla forma particolare, a campana... o zampa di elefante... un tronco cono tondeggiante da rivestire a contrasto o coordinato... Da utilizzare in molti modi indifferentemente come seduta tavolino piano d'appoggio e in due versi, sopra sotto, piu stabili o più larghi.

Uniquely shaped padded seats, bell or elephant paw-shaped... truncated round cones to be covered with contrasting or matching fabric... To be used in many ways, as a seat, coffee table and top, in two ways, top-bottom, more stable or wider.

Éléments rembourrés sympathiques de forme particulière, en cloche... ou en patte d'éléphant... un tronc conique rond à habiller ton sur ton ou avec une autre couleur... À utiliser indifféremment de plusieurs façons, comme assise, table d'appoint et dans les deux sens, à l'envers ou non, pour une version plus stable ou plus large.



Fuji

Pouf

Caratteristiche tecniche

Struttura - Realizzata in agglomerato di legno di spessore 10mm. Il tutto trattato al naturale in classe E1, pertanto a bassa emissione di formaldeide. Il telaio è completamente rivestito con vellutino 100% poliammine termoaccoppiato a ovatta resinato da 200 gr di 100% poliestere.

Imbottitura

Seduta: lastra in poliuretano espanso flessibile e indeformabile in densità D30TL fresato tondo sul perimetro, totalmente rivestito in vellutino in poliammine 100% accoppiato a falda di resinato in poliestere da 200 gr.

Parti di tamponamento perimetrale: lastre sagomate di poliuretano indeformabile in D16S. I materiali corrispondono alle normative europee 91/156/etc. Informazioni ambientali sulla sicurezza: la deperibilità del prodotto, secondo la sua composizione, è praticamente nulla. Le resine non sono contenute nella lista della normativa di classificazione dei rifiuti per materiali soggetti a particolare sorveglianza. Le resine espansive sono esenti da freon e solventi clorurati. Le resine espansive non contengono sostanze che danneggiano l'ozonofera e non vengono fabbricate con prodotti menzionati nel protocollo di Montreal e Regolamento (CE) n. 3093/94.

Piedini in abs nero da 20mm

Technical characteristics

Structure - Made of 10 mm thick chipboard. All treated naturally in Class E1, thus with low formaldehyde emissions. The frame is completely covered with 100% polyamines velvet. The thermo-coupled with 200 g. 100% polyester wadding resin.

Padding

Seat: sheet of flexible and non-deformable polyurethane foam, D30TL, milled around the perimeter, completely covered with 100% polyamine velvet coupled with a layer of 200g polyester resin.

Perimeter structural parts: D16S polyurethane foam sheets. The materials meet the European standards 91/156/etc. Environmental information on safety: The perishable nature of

the product, according to its composition, is practically nil. Resins are not included in the list of standards for the classification of waste materials subject to special surveillance. Resin foams are free from freon and chlorinated solvents. Resin foams do not contain substances that damage the ozone layer and are not manufactured with products mentioned in the Montreal Protocol and (CE) Regulation no. 3093/94.
20mm high black ABS **feet**.

Caractéristiques techniques

Structure - Réalisée en aggloméré de bois de 10 mm d'épaisseur. Le tout traité au naturel en classe E1, soit à faible émission de formaldéhydes. Le cadre est entièrement recouvert de velours 100% polyamines couplé à chaud à une couche de résine de polyester de 200 g.

Rembourrage

Siège: plaque en mousse de polyuréthane souple et indéformable densité D30TL fraisée ronde sur le pourtour et totalement recouverte de velours 100% polyamines couplé à chaud à une couche de résine de polyester de 200 g.

Éléments de remplissage de contour : plaques découpées en polyuréthane indéformable en D16S. Les matériaux sont conformes aux normes européennes 91/156/etc. Informations environnementales sur la protection : la nature périssable du produit, sur la base de sa composition, est pratiquement nulle. Les résines ne figurent pas dans la liste établie par la norme de classification des déchets de matériaux soumis à une surveillance particulière. Les résines expansées ne contiennent pas de fréon ni de solvants chlorés. Les résines expansées ne contiennent pas de substances nuisibles à la couche d'ozone et ne sont pas fabriquées avec des produits figurant dans le Protocole de Montréal et le Règlement (CE) n° 3093/94.

Pieds en ABS noir de 20 mm.



H 42



H 42



H 42



Pouf / Ottoman / Pouf

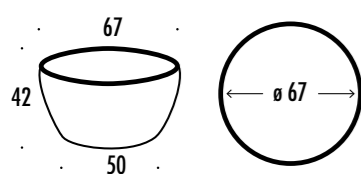

L. W. L. 67 - P. D. P. 67 - H. H. H. 42

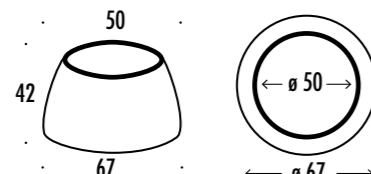

L. W. L. 67 - P. D. P. 67 - H. H. H. 42

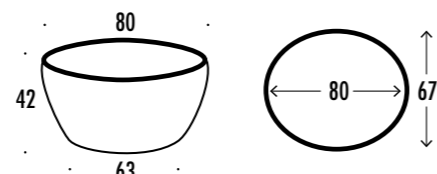

L. W. L. 80 - P. D. P. 67 - H. H. H. 42



Made in Italy.
La qualità garantita, che mi rende sicuro.

Tutti i modelli presentati in questo catalogo sono prodotti nella sede dell'azienda in Italia, con materiali certificati, da maestranze qualificate. Le tecnologie costruttive sono di ultima generazione e nei casi in cui la lavorazione manuale si renda indispensabile per un migliore risultato qualitativo essa è impiegata senza riserve. L'Italia vanta una lunga e nobile tradizione nel mondo dell'arredamento e dei mobili imbottiti, che la nostra azienda si pregia di proseguire e tutelare.

Made in Italy.
Guaranteed quality, which gives you assurance.

All the models presented in this catalogue are manufactured on the company's premises in Italy, with certified materials, by qualified workers. Latest-generation constructional technologies are implemented and, when considered essential for higher-quality results, manual processing is used without reservation. Italy boasts a long and distinguished tradition in the furnishing and upholstered furniture sector, which our company is pleased to continue and protect.

Made in Italy.
Une qualité garantie qui me conforte.

Tous les modèles présentés dans ce catalogue sont produits dans le siège de l'entreprise en Italie, avec des matériaux certifiés, par un personnel qualifié. Les technologies de fabrication sont de dernière génération et si le travail manuel est indispensable pour un meilleur résultat qualitatif, il est utilisé sans réserves. L'Italie vante une longue et noble tradition dans le monde de l'ameublement et notamment des meubles rembourrés, que notre société est heureuse de poursuivre et de protéger.

Utilizzo dei cataloghi e dei campionari.

La proprietà e la gestione di questo catalogo sono della Felis Felix S.r.l.; tutti i materiali presenti al suo interno, compresi testi, immagini ed illustrazioni, nonché i campionari, sono tutelati da copyright posseduti e controllati da Felis Felix S.r.l. L'utente riconosce e accetta il divieto di copiare, riprodurre, ripubblicare, trasmettere, comunicare, modificare, utilizzare per altri scopi, inviare o distribuire in alcun modo il materiale in questione senza la preventiva autorizzazione scritta della Felis Felix S.r.l. Eventuali utilizzi non consentiti del materiale in questione costituiscono una violazione dei copyright e dei diritti di proprietà e potranno pertanto essere perseguiti a norma di legge da parte di Felis Felix S.r.l. nei confronti di chiunque ne faccia un uso non corretto.

Using the catalogues and sample books.

This catalogue is the property of Felis Felix S.r.l., which retains all rights concerning its utilization. All the material contained in the catalogue, including text, photographs and illustrations, as well as the sample books, are protected by copyrights owned and controlled by Felis Felix S.r.l. The user acknowledges and accepts that it is strictly prohibited to copy, reproduce, re-publish, transmit, communicate, modify, use for different purposes, send or distribute the material in question in any way without the prior written consent of Felis Felix S.r.l. Any unauthorized utilization of the material in question constitutes a breach of copyright and of the company's intellectual rights. In such event, Felis Felix S.r.l. reserves the right to take the appropriate legal action against whomsoever might use the material in an inappropriate fashion.

Utilisation des catalogues et de l'échantillonnage.

Felis Felix S.r.l. est le propriétaire de ce catalogue et en assure la gestion; tous les matériaux qui y sont contenus, y compris les textes, les images, les illustrations et les échantillons sont protégés par les droits d'auteur détenus et contrôlés par Felis Felix S.r.l. L'utilisateur reconnaît et accepte l'interdiction de copier, reproduire, republier, transmettre, communiquer, utiliser pour d'autres finalités, envoyer ou distribuer de quelque façon que ce soit le matériel en question sans l'autorisation préalable et écrite de Felis Felix S.r.l. D'éventuelles utilisations non autorisées du matériel en question constituent une violation des droits d'auteur et des droits de propriété et, en vertu de la loi, Felis Felix S.r.l. pourra dénoncer quiconque en fait un usage incorrect.

RESEARCH & DESIGN
BY FELIS LAB

ART DIRECTION
Gianluca Marcon

FOTOGRAPHY
Studio Auber

DIGITAL OPERATOR
Paolo Chiarot

STYLING
Federica Baro

COPYWRITING
AREAteam

PRINT
Eurotipo

L'azienda si riserva il diritto, in qualsiasi momento e senza preavviso di eliminare gli articoli che riterrà opportuno e/o di apportare tutte le modifiche atte a migliorare il prodotto. Non può inoltre assumersi la responsabilità per eventuali inesattezze del presente catalogo dovute a errori di stampa, trascrizione e traduzione. Tutti i diritti sono riservati.

Our company reserves the right at any time and without notice to withdraw items that it deems appropriate and/or to make any changes to improve the product. Moreover, we shall not take responsibility for any inaccuracies in this catalogue due to printing errors, transcription and translation. All rights reserved.

La société réserve le droit, à tout moment et sans préavis, de supprimer des articles et/ou d'apporter des modifications pour améliorer le produit. De plus, elle n'assumera aucune responsabilité en cas d'inexactitudes constatées dans ce catalogue dues à des erreurs d'impression, de transcription et de traduction. Tous droits réservés.



Felis
SOFT LIVING

FELIS FELIX srl
Via Mezzomonte, 23
33077 Sacile (PN) Italy
tel. +39 0434 737052
fax +39 0434 737024
info@felis.it ##
~ ~ ~ 5hsz 51

FELIS FELIX srl
Via Mezzomonte, 23
33077 Sacile (PN) Italy
tel. +39 0434 737052
fax +39 0434 737024
info@felis.it
www.felis.it

EXPERIENCE

HAND MADE IN ITALY SINCE 1990

Felstyle

HOME INTERIOR COMFORT GUIDE

BEDSTORIES

NIGHT COLLECTION

Day & Night

ITALIAN SOFA-BED COLLECTIONS



Felis
SOFT LIVING