

# .detail 1

the new contemporary

tables & seats





Everything we do, just the way it is

There usually is a certain passion regarding what is seen from the distance. Distance reminds us of romance, yet it has a secondary effect: it hides, it avoids, it standardizes. Nothing could be further away from what we mean to give you. We could do it, if only we did not know how much time we spent making our designers' ideas real. We could do it, if we tried to make imperfect materials better, rather than choosing the best ones. We should do it, if we were not sure we took perfect care of every single detail. We will not do it. Everything we create is here in front of you, and we'd want you to see it, just the way it is.







# arpa

design\_Angelo Tomaiuolo

Arpa è un tavolo che ricerca l'armonia, nelle forme e nei materiali. Si presenta con piani in vetro ceramico o marmo. A sostenerlo, una base realizzata in multistrato termo curvato, e impiallacciata in noce o rovere scuro termotrattato. Una versione fissa, classica come la musica cui si ispira; una versione allungabile con un binario in alluminio, contemporanea e funzionale. Il design è audace, e caratterizza tutto il programma Arpa, che oltre al tavolo prevede una consolle.

Arpa pursuists harmony, both in shapes and materials. It comes with tempered glass, ceramic and marble tops. Thermoformed wooden legs sustain it. Both Canaletto walnut and heat-treated dark oak are available. One fixed version, just as classic as the music from which it got its inspiration; an extendible version, whose aluminum guide bar makes it contemporary and functional. This daring design fully represents the entire Arpa system: table and console table.

Агра стремится к гармонии, как в формах, так и в материалах. Он создан из закаленного стекла с керамическими и мраморными поверхностями. Его поддерживают термоформованные деревянные ножки. Доступны оба: грецкий орех Каналетто и термообработанный темный дуб. Одна версия — фиксированная и настолько же классическая, как и музыка, от которой она получила свое вдохновение; раздвижная версия имеет алюминиевую направляющую планку, которая придает современный и функциональный характер. Этот смелый дизайн полностью представляет всю систему Агра: стол и консольный стол.

## 8002FSV - 8002FSM

(A) L 200 P 100 H 75 cm  
(G) L 250 P 120 H 75 cm

## 8002FSL - 8002FSC

(A) L 200 P 100 H 75 cm  
(G) L 250 P 120 H 75 cm  
(Z) L 300 P 120 H 75 cm

## 8002

(P) L 160/240 P 90 H 75  
(A) L 180/260 P 90 H 75  
(G) L 200/300 P 100 H 75  
(D) L 200/300 P 110 H 75



**Arpa 8002**  
Extendible table: white ceramic glass top (V01C);  
polished aluminum guide-bar (71);  
Canaletto walnut base (14).





**Arpa 8002**  
Extendible table: white ceramic glass top (V01C); polished aluminum guide-bar (71); Canaletto walnut base (14)



Arpa 8002FSM  
Fixed table: white Carrara marble top (M\_101);  
dark oak base (16).



Un dettaglio, che descriva perfettamente quanta cura mettiamo nella lavorazione del legno: la curva delicata e morbida rende questo materiale un'opera, un simbolo di eleganza e qualità, da custodire là dove si condividono i momenti più sinceri. Arpa si può abbinare ad ogni gusto, grazie alla varietà di materiali disponibili, ed alla combinazione ideale di forme e colori.

A detail, to perfectly describe how carefully we work on wood: a smooth and delicate curve makes this material an actual piece of art, symbol of both elegance and quality, made to be held where the sincerest moments are shared. Arpa can satisfy everybody's taste, thanks to the availability of different materials, and to the perfect combination of shapes and colors.

Деталь, которая как нельзя лучше свидетельствует о том, сколько внимания мы уделяем обработке дерева. Изысканные мягкие изогнутые линии делают этот предмет мебели произведением искусства, символом утонченности и качества, сокровищницей, с которой можно разделить самые искренние минуты нашей жизни. Элемент Арпа отлично впишется в любой интерьер благодаря разнообразию материалов отделки и безукоризненному сочетанию форм и оттенков.



# brenta

design\_Angelo Tomaiuolo

Brenta parte dall'idea di una base che sia in grado di accordarsi a differenti ambienti: il metallo curvato si tinge di bianco, bronzo pietra o grigio carbone, abbinandosi perfettamente ad ogni stanza. Brenta premia la naturalezza del legno, la tenacità del vetro e il lusso del porcellanato.

The idea behind Brenta table, was to build a base that could fit in different locations: the curved metal can be painted white, stone bronze, or carbon grey, making it perfect for every room. Brenta chooses wood's natural soul, glass tenacity and porcelain stoneware luxury.

Идеей стола Brenta было создать основание, которое сможет вписаться в различные обстановки: гнутый металл может быть окрашен в белый цвет, цвет каменной бронзы или цвет серого углерода, что делает его идеальным для каждого помещения. Brenta выбирает естественную душу дерева, прочность стекла и роскошь керамогранита.

## 8057FSV - 8057FSL - 8057FSC

(LP) L 133 P 133 H 75 cm  
(LA) L 200 P 100 H 75 cm  
(LG) L 250 P 120 H 75 cm  
(LZ) L 300 P 120 H 75 cm

## 8057FLM

(A) L 200 P 106 H 75 cm  
(G) L 250 P 106 H 75 cm  
(Z) L 300 P 120 H 75 cm



**Brenta 8057FSL**  
Matt white lacquered, curved metal base (01);  
Canaletto walnut top (14)



**Brenta 8057FSL**  
Stone bronze lacquered, curved metal  
base (83); dark oak heat-treated top (16)

# brooklyn

design\_Studio 28

La solida durevolezza di un luogo ormai mitico come Brooklyn, ci ha ispirati per questo tavolo: una base in legno, geometrica e regolare, su cui poggiano piani fissi o allungabili, nelle varianti di vetro temperato, e ceramica.

The solid endurance of an almost legendary city - Brooklyn - was the inspiration leading to this table: a wooden, regular and geometric base, onto which fixed, or extendible tops are placed. Both tempered glass and ceramic glass are available for the tops.

Абсолютная стойкость практически легендарного города Бруклин стала вдохновением для создания этого стола: деревянное, стандартное и геометрическое основание, к которому прикреплены фиксированные или раздвижные поверхности. Для поверхности доступны оба: закаленное стекло и стекло с керамическим покрытием

## 8000FSV - 8000FSC

(FP) L 160 P 90 H 75 cm  
(FA) L 180 P 90 H 75 cm  
(FG) L 200 P 100 H 75 cm

## 8000

(P) L 160/240 P 90 H 75  
(A) L 180/260 P 90 H 75  
(G) L 200/300 P 100 H 75

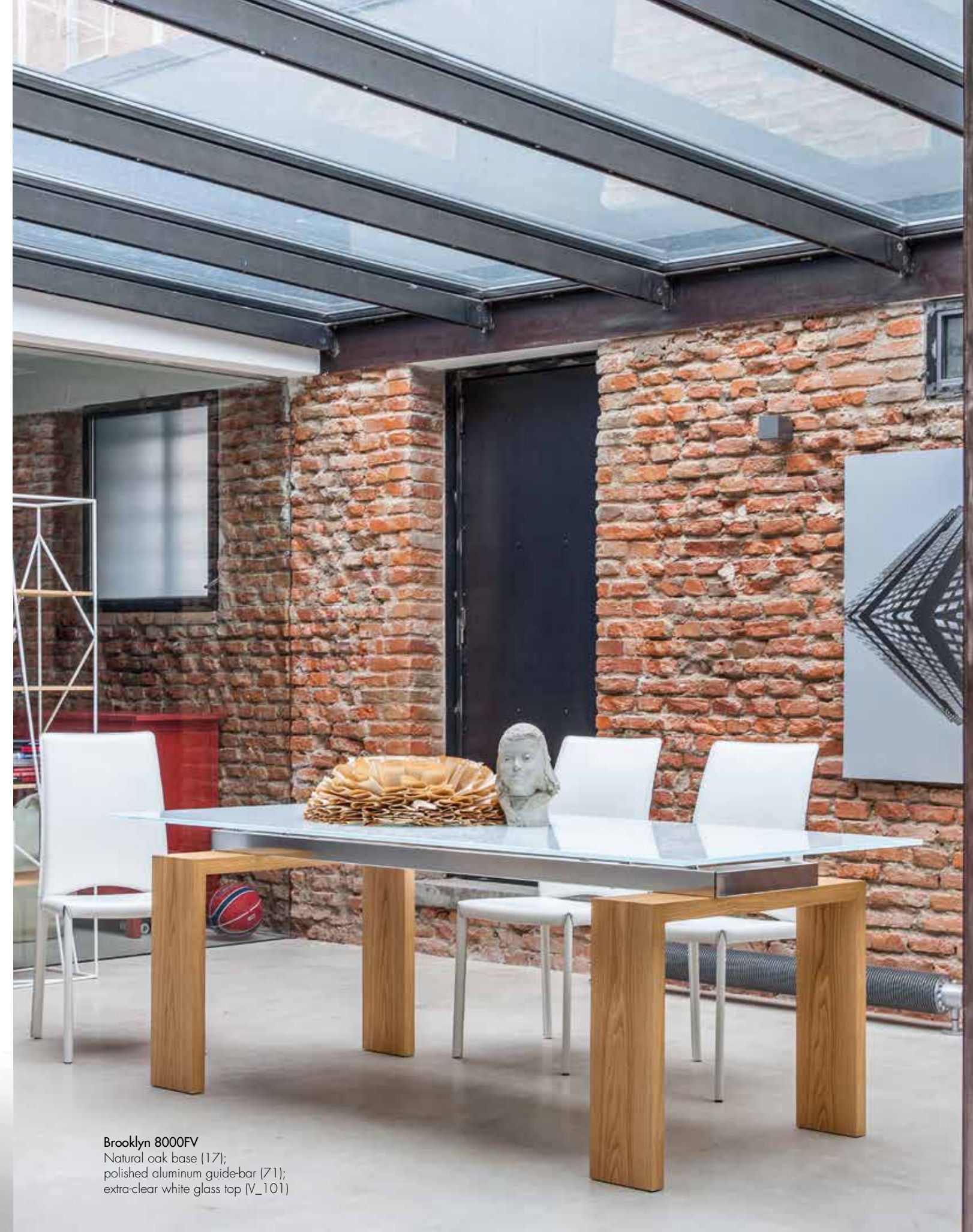

Brooklyn 8000FV  
Natural oak base (17);  
polished aluminum guide-bar (71);  
extra-clear white glass top (V\_101)



Brooklyn 8000  
Grey ceramic glass top (V\_04C);  
carbon grey lacquered aluminum guide-bar (10);  
heat-treated dark oak base (16)



**Brooklyn 8000**  
Transparent bronze glass top (V\_84);  
carbon grey lacquered aluminum  
guide-bar (10);  
Canaletto walnut base (14)

Una forza sottile: quest'idea sale alla mente, osservando lo stacco tra il colore del piano, un vetro fumé trasparente, e la pacata naturalezza della base in legno rovere scuro termotrattato. Il design di Brooklyn è regolare e semplice, pensato per esaltare le diversità materiche, e le colorazioni di cui si può comporre.

A subtle strength: this is the idea that comes to one's mind, while observing the difference existing between the top's color – a fume grey, transparent glass – and the quiet nature of the heat-treated dark oak base. Brooklyn's design is regular and simple, thought to bring out the differences between materials, and the colorations you can use to compose it.

Хрупкая сила - такая идея приходит на ум, когда смотришь на контраст между цветом столешницы, прозрачным дымчатым стеклом и спокойной естественностью основания из термообработанного темного дуба. Дизайн стола Brooklyn - точный и простой, созданный, чтобы подчеркнуть различие материалов и красок.



# butterfly

design\_Angelo Tomaiuolo

Le gambe in legno di Butterfly combinano un design leggero, lieve e delicato, con la solida dolcezza del legno curvato. Esattamente come le farfalle, anche per questo tavolo i colori cambiano quasi infiniti, nelle varianti di vetro temperato, grès porcelanato, marmo e legno. Potrete trasformare le vostre stanze, con la grazia di una farfalla.

Butterfly's wooden legs combine a light, mild and delicate design, with curved wood's solid sweetness. Like butterflies, colors change almost infinitely, from the tempered glass finishes, through porcelain, marble and up to wood. You now can transform your rooms, as gracefully as a butterfly.

Деревянные ножки Butterfly сочетают в себе легкий, спокойный и утонченный дизайн с очарованием гнутого массива дерева. Как бабочки, цвета меняются практически бесконечно с отделками из закаленного стекла, фарфора, мрамора и дерева. Теперь вы можете изменять ваши комнаты так же изящно, как бабочка.

## 8070FSV

(T) Ø 160 H 75 cm  
(P) L 133 P 133 H 75 cm  
(A) L 200 P 106 H 75 cm  
(G) L 250 P 106 H 75 cm  
(Z) L 300 P 120 H 75 cm

## 8070FSL

(LP) L 133 P 133 H 75 cm  
(LA) L 200 P 100 H 75 cm  
(LG) L 250 P 120 H 75 cm  
(LZ) L 300 P 120 H 75 cm

## 8070FSM

(T) Ø 160 H 75 cm  
(P) L 133 P 133 H 75 cm  
(A) L 200 P 106 H 75 cm  
(G) L 250 P 106 H 75 cm

## 8070FSC

(P) L 133 P 133 H 75 cm  
(A) L 200 P 106 H 75 cm  
(G) L 250 P 106 H 75 cm  
(Z) L 300 P 120 H 75 cm

## 8070FV

(FP) L 160 P 90 H 75 cm  
(FA) L 180 P 90 H 75 cm  
(FG) L 200 P 100 H 75 cm

## 8070

(P) L 160/240 P 90 H 75 cm  
(A) L 180/260 P 90 H 75 cm  
(G) L 200/300 P 100 H 75 cm

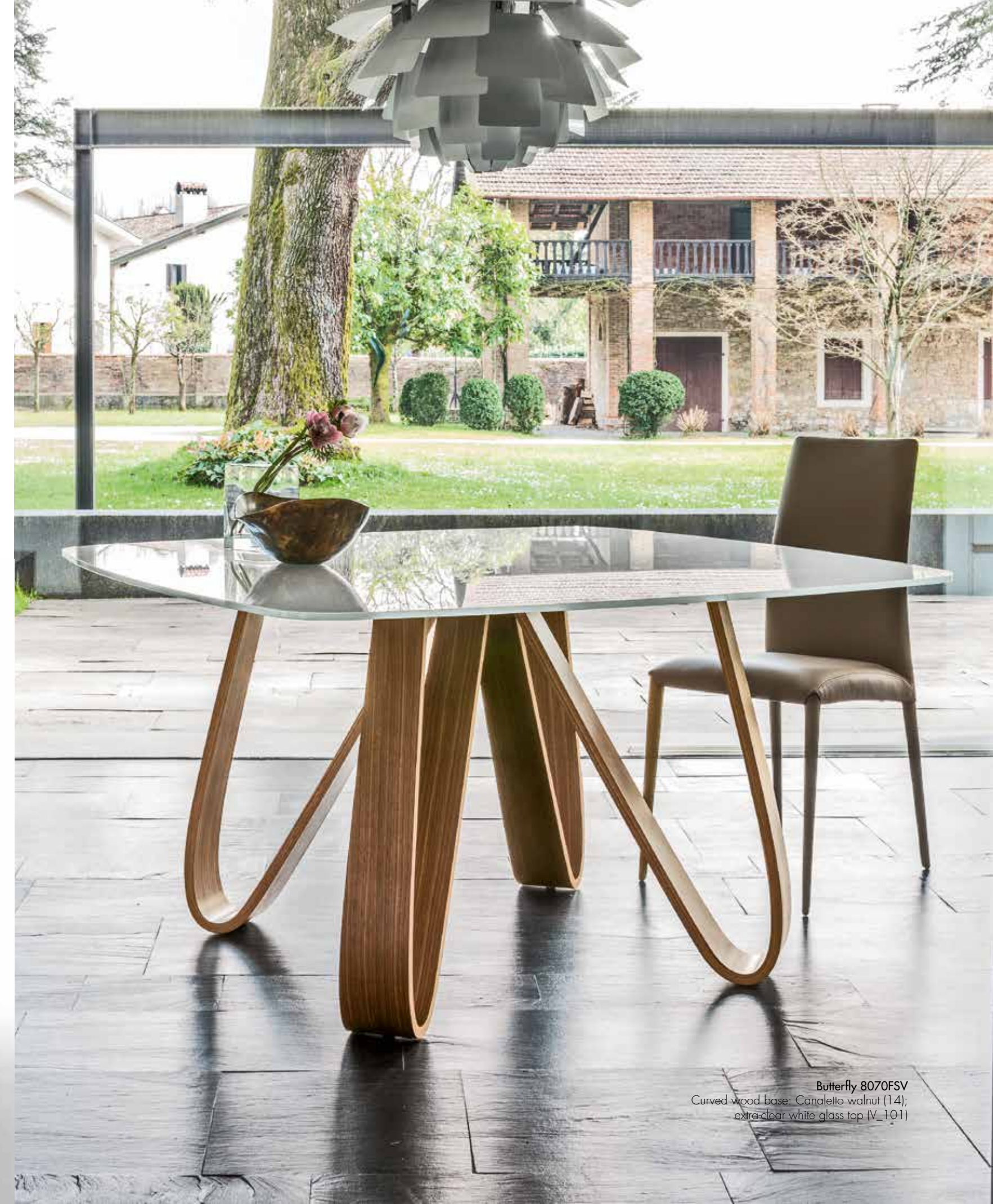

Butterfly 8070FSV  
Curved wood base: Canaletto walnut (14);  
extra-clear white glass top (V\_101)



Butterfly 8070FSM  
Curved wood base: Canaletto walnut(14);  
matt white Carrara marble top (M\_101)





Butterfly 8070FSC  
Curved wood base: Canaletto walnut  
(14); Statuario Altissimo porcelain  
stoneware top (V\_01P)



Butterfly 8070  
Extendible table:  
curved wood, lacquered matt white base (01);  
anodized aluminum guide-bar (32);  
frosted extra-clear white top (V\_101)



**Butterfly 8070**  
Extendible table:  
curved wood base, heat-treated dark oak (16);  
carbon grey lacquered aluminum guide-bar (10);  
black ceramic glass top (V\_02C)

# capri

design\_Angelo Tomaiuolo

La forza della struttura in metallo, unita all'elegante base di marmo ed al piano fisso in vetro, delicato e resistente, rende Capri un tavolo simbolo dell'italianità. Ricco di un lusso discreto, scintillante e raffinato, è rappresentazione di cura, precisione e devozione. Ancora una volta, materiali e tecnica, natura e innovazione, tesi alla creazione di un oggetto di eccezionale equilibrio.

The strength of the metal structure joins the elegant marble legs and the fixed glass top, making Capri a symbol of the Italian essence. It is enriched by a discreet luxury, shining and refined, it represents care, precision and devotion. Once again, materials and technique, nature and innovation aim at creating an exceptionally balanced product.

Сила металлической структуры в сочетании с элегантностью мраморной основы и фиксированной столешницы из на первый взгляд хрупкого, но очень прочного стекла делает стол Capri символом итальянского стиля. Полный сдержанной роскоши, игривый и утонченный дизайн – это результат внимательности, точности и огромной любви к своему делу. Это еще один пример того, как материя и техника, природа и человеческий гений становятся основой создания безукоризненного равновесия.

## 8069FSV

(T) Ø 140 H 75 cm  
(P) Ø 160 H 75 cm  
(A) Ø 180 H 75 cm  
(E) L 220 P 120 H 75 cm

## 8069FSL

(T) Ø 140 H 75 cm  
(P) Ø 160 H 75 cm  
(E) L 220 P 120 H 75 cm



Capri 8069FSV  
Matt bronze Emperador marble base (M\_183);  
Stone bronze varnished metal structure (83);  
elliptical top: extra-clear transparent glass (V\_100)



Capri 8069FSL  
Glossy black Marquinia marble base (M\_102);  
matt black varnished metal structure (02);  
elliptical top: Canaletto walnut (14)



**Capri 8069FSV**  
Glossy white Carrara marble base (M\_101); matt white varnished metal structure (01); extra-clear transparent glass top (V\_100)

Avvicinarsi, quasi accarezzare con lo sguardo quest'affascinante texture. Immaginare i cambiamenti, le diversità del marmo nero Marquinia, del bianco di Carrara, dell'Emperador. Abbinare colorazioni di metallo e creare leggerezza oppure forza, morbidezza e pure rigore. Osservare la luce rifratta sul vetro di un piano semplice e raffinato.

Get close, almost touching this fascinating texture with your eyes. Imagine the differences, from black Marquinia marble, to Carrara marble, to the Emperador. Match metallic colors and create lightness, or strength, softness, or exactitude. Observe the light refracted on the simple, yet refined top's glass.

Текстура словно манит подойти, прикоснуться, обласкать взглядом. Представить себе чередование разнообразий черного мрамора Марквины, белого мрамора Каррары, Эмперадор Дарк. Сочетать металлические оттенки таким образом, чтобы создать эффект одновременной легкости и силы, мягкости и устойчивости. Радовать свой взор игрой изломов лучей на элегантной в своей простоте стеклянной столешнице.



# colosseo & big colosseo

design\_Nicola Tonin

Un altro omaggio all'Italia, nella forma e nella sensazione di calore ed equilibrio. Una base in legno massiccio noce o rovere scuro, a reggere piani fissi o allungabili, in vetro, vetro ceramizzato o marmo.

Another homage to Italy itself, in the shape and sensation of warmth and balance. A solid walnut, or dark oak base, to carry fixed or extendible tops, made out of glass, ceramic and marble.

Еще одна дань уважения к Италии, в форме и ощущении тепла и равновесия. Основание из массива ореха или темного дерева дуба поддерживает обычную или раздвижную столешницу из стекла, керамического стекла или мрамора.

## 8076FSV - 8076FSC

(T) Ø 140 H 75 cm  
(P) Ø 160 H 75 cm  
(A) Ø 180 H 75 cm  
(E) L 220 P 120 H 75 cm

## 8076FSM

(T) Ø 160 H 75 cm  
(P) L 200 P 100 H 75 cm  
(A) L 250 P 100 H 75 cm

## 8076

(P) L 160/240 P 90 H 75 cm  
(A) L 180/260 P 90 H 75 cm  
(G) L 200/300 P 100 H 75 cm  
(D) L 200/300 P 110 H 75 cm

## 8076

(P) L 160/240 P 90 H 75 cm  
(A) L 180/260 P 90 H 75 cm  
(G) L 200/300 P 100 H 75 cm

## 8077FV

(OK) L 260 P 120 H 75 cm  
(OX) L 300 P 120 H 75 cm  
(RZ) L 240 P 120 H 75 cm  
(RK) L 300 P 120 H 75 cm



Colosseo 8076FSM  
Solid Canaletto walnut base (M\_14);  
Emperador bronze marble top (M\_183).

Colosseo 8076FSV  
Solid Canaletto walnut base (LM\_14);  
extra-clear transparent glass top (V\_100).





**Colosseo 8076**  
Extendible table: solid dark oak base  
(LM\_16); polished aluminum guide-bar  
(71); grey ceramic glass top (V\_04C)

Big Colosseo 8077FV  
Solid Canaletto walnut base (LM\_14);  
transparent fumé glass top (V\_85).



I mattoncini in legno massiccio si accostano precisi, ad imitazione della potenza del Colosseo. Riescono a ricordare ad un tempo un monumento ed un'opera d'arte. La struttura circolare poggia su una lamina sottile, è studiata per ottenere morbidi effetti di luce, per alleggerire la forza di questo tavolo omaggio ad una straordinaria opera architettonica italiana.

These small solid wood bricks match precisely, imitating Coliseum's strength. They remind us of a monument and a piece of art at the same time. The circular structure was put on a thin layer; it was made to obtain a soft lighting effect that enhances this table's strength. An homage to an extraordinary Italian building.

Кирпичики из массива дерева располагаются в точной симметрии в подражание мощности и величия Колизея. Это дань невероятному историческому памятнику и произведению искусства. Круговая структура опирается на тонкую пластину. Дизайн разработан специально для того, чтобы путем игры света сделать более воздушной форму стола, названного в честь уникального итальянского архитектурного памятника.



# dafne

design\_Angelo Tomaiuolo

Allunghe arrotondate, studiate con raffinatezza per renderne l'utilizzo il più agevole possibile, ogni giorno; geometrie e forme rigorose, dal gusto fresco e giovanile; piano e struttura in legno, a ricordare la naturalezza più essenziale della materia: la semplice classe del tavolo Dafne.

Smooth out extensions, conceived to make their use as easy as possible, every day; strict geometries, young and fresh; wooden structure and top, to remind materials' essential nature: Dafne, simply classic.

Скругленные удлиненные формы, тщательно изученные для того, чтобы создать изысканное и одновременно удобное и практичное ежедневное пользование. Строгие формы и дизайн, но со штрихом юношеской свежести. Столешница и несущая структура из дерева подчеркивают естественность и саму сущность материи. Все это – изысканная простота стола Dafne.

8075

(P) L 140/188 P 90 H 75 cm  
(A) L 160/208 P 90 H 75 cm



Dafne 8075  
Extendible table:  
ash wood, open pore matt white structure (01);  
open pore, white painted oak top (01)



Dafne 8075  
Extendible table:  
natural oak structure and top (17)

Il progetto per la creazione di Dafne parte da un concetto molto semplice: l'essenza. Guardando da vicino la linea chiara e snella della gamba, si nota come Dafne riesca a mantenere la vivacità di un oggetto fondamentale in ogni abitazione, e nel contempo renderlo in grado di essere personale e utile. Ed è proprio questa la sua essenza: un minimalismo sobrio, contemporaneo per funzioni e possibilità di essere posto all'interno di spazi di ogni genere.

Dafne's project starts out of a simple concept: essence. It is easy to notice how the clear and skinny legs are capable of providing liveliness in every home, and at the same time make Dafne a personal and useful object. And this is exactly its essence: a sober minimalism, for an easy-to-arrange product.

В основе проекта стола Dafne лежит простая концепция: дерево. Всмотревшись внимательнее в четкие и стройные линии ножки стола, можно сразу же понять, почему Dafne удается сохранить динамизм такого важного для любого жилья элемента, как стол, и одновременно являться полезным предметом обихода и стильным предметом интерьера, отражающим персональный характер. В этом и кроется сущность дерева: трезвый минимализм, современные функции и способность отлично вписаться в любой интерьер.





# eliseo & big eliseo

design\_Studio 28

Un'ellissi di legno in diverse essenze, o di vetro temperato elettro-saldato a raggi UV su di una piastra d'acciaio; il tutto poggiato su di una base in metallo curvato e verniciato, ad ottenere un effetto di grande ricercatezza estetica. Con Eliseo, nasce un tavolo da pranzo di estrema raffinatezza, disponibile anche in versione tricolore e a doppia base, capace di adattarsi a stanze di diverse dimensioni.

A wooden ellipse made of tempered glass, electrically welded by UV rays onto a steel plate; all of it is gently put on top of curved, varnished metallic legs, so to obtain a great aesthetic value. With Eliseo, a dining room was born, extremely refined, and available in the three-colors version, or with a double base.

Эллиптическая конструкция из разных пород дерева или каленого стекла, зафиксированного на стальной плите путем УФ-электросварки. Вся конструкция устанавливается на опору из гнутого металла с защитным покрытием, которая придает композиции невероятно утонченный эффект. Eliseo положил начало поколению чрезвычайно изысканных обеденных столов. В наличии трехцветные модели, модели с двумя опорными конструкциями, которые отлично подойдут для просторных помещений.

## 8028FSV - 8028FSC

(TP) Ø 120 H 75 cm  
(T) Ø 140 H 75 cm  
(EL) L 200 P 105 H 75 cm

## 8028FSL

(P) Ø 120 H 75 cm  
(A) Ø 140 H 75 cm  
(EL) L 220 P 120 H 75 cm

## 8057FLM

(G) L 250 P 106 H 75 cm  
(Z) L 300 P 120 H 75 cm

## 8061FV

(OK) L 260 P 120 H 75 cm  
(OX) L 300 P 120 H 75 cm  
(RZ) L 240 P 120 H 75 cm  
(RK) L 300 P 120 H 75 cm



Eliseo 8028FSV  
3-colors (white/beige/mud), lacquered metal base (31);  
extra-clear transparent glass top (V\_100).





Eliseo 8028FSL  
3-colors (white/beige/mud) lacquered  
metal top (31); Canaletto walnut elliptical  
top (14)

Big Eliseo 8057FLM  
Stone bronze lacquered metal base (83);  
solid walnut top (LM\_14).



Il movimento creato dall'intreccio della base si unisce alla perfetta laccatura, illuminando Eliseo, e rendendolo così ideale sia per ambienti moderni, che per luoghi dal gusto più classico. Un tavolo dettagliato e personalizzabile, indice del vero made in Italy di Tonin Casa.

The movement created by the twisted legs joins the perfect lacquering, it enlightens Eliseo, while making it perfect for both modern and classic spaces. A detailed, customizable table, defining what "Made in Italy" means to Tonin Casa.

Динамичность переплетения компонентов основания отлично сочетается с безупречной лаковой отделкой, придавая столу Eliseo новое сияние и делая эту модель идеальной для как для современного, так и для классического интерьера. Стол с ярко выраженными деталями, дающий возможность подчеркнуть персональный стиль. Олицетворение концепции подлинного made in Italy от мебельного дома Tonin Casa.



# firenze & big firenze

design\_Nicola Tonin

La caratteristica principale del tavolo Firenze è la base di listelli in legno massiccio noce canaletto, o rovere scuro. I listelli vengono accoppiati uno ad uno, per creare una scultura a spirale che crei un elegante effetto ottico. Un piano in vetro, disponibile in più misure, chiude la struttura. L'originalità di Tonin si mescola qui a precisione, qualità e praticità: il tavolo è infatti disponibile sia con base singola che con base doppia.

Firenze table's main characteristic regards its base: it is made with solid Canaletto walnut, or solid dark oak slats. The slats are paired one by one, forming a spiral sculpture that creates an elegant optical illusion. A glass top, available in different sizes, completes the structure. Tonin Casa's originality, mixes precision, quality and practicality: the table, in fact, is available with both the single and the double base.

Главной особенностью стола Firenze является планок массива черного ореха или дуба. Планки соединены между собой в спиральную структуру, создающую элегантный зрительный эффект. Завершает структуру стеклянная столешница, размеры которой можно выбрать по заказу. Оригинальность идей Tonin здесь сочетается с точностью, качеством и практичностью: в наличии выбор моделей с одинарным и двойным основанием.

## 8067FSV

(P) Ø 120 H 75 cm  
(A) Ø 140 H 75 cm

## 8078FV

(OK) L 260 P 120 H 75 cm  
(OX) L 300 P 120 H 75 cm  
(RZ) L 240 P 120 H 75 cm  
(RK) L 300 P 120 H 75 cm



Firenze 8067FSV  
Solid Canaletto walnut base (LM\_14);  
extra-clear transparent glass top (V\_100).



**Big Firenze 8078FV**  
Double base: solid dark oak (LM\_16);  
extra-clear transparent glass top (V\_100).

Come una scala a chiocciola che si rifletta su di un lago, sollevandosi leggera, un'opera d'arte che si può utilizzare nella vita quotidiana: Firenze unisce calore, sobrietà e inventiva. La precisione nel posizionamento di ciascun listello in legno massiccio è a buon diritto un motivo di vanto per tutti gli artigiani di Tonin Casa.

Just like a spiral staircase reflecting a lake, lightly hovering, a piece of art you can use in your everyday life: Firenze combines warmth, sobriety and inventiveness. Precision in positioning every solid wood slat is the rightful reason for Tonin Casa's artisans to feel proud.

Ножка стола кажется парящей винтовой лестницей, отражающейся на озерной глади. Это настоящее произведение искусства, используемое в повседневной жизни: стол Firenze сочетает в себе теплоту, строгость форм и изобретательность. Точность позиционирования каждой деревянной пластины по праву является источником гордости мастеров мебельного дела Tonin Casa.



# gaya & big gaya

design\_Angelo Tomaiuolo

Gaya rappresenta la tecnologia che incontra il design: una base in tecnoril® dalle tinte opache si piega a formare linee eleganti e leggere. Il materiale d'avanguardia, e la particolare forma della base, creano effetti di diversa complessità, a seconda che si scelga la versione Gaya, o la Big Gaya, con doppia base. In appoggio, un piano in vetro temperato, che rifinisce ed esalta la base curvilinea.

Gaya represents technology meeting design: a tecnoril® base, matt colored, bends and creates elegant, light lines. This avant-garde material, combined with the peculiar shape of the base, create wildly complex effects, that change as the choice changes: do you prefer the Gaya version, or the double-based Big Gaya.

Гауа представляет технологичный дизайн: основа tecnoril® с матовым цветом изгибается и создает элегантные и легкие линии. Этот авангардный материал в сочетании с особенной формой основания, создает невероятно сложные эффекты, которые изменяются с выбором: вы предпочитаете версию Гауа или Big Гауа с двойным основанием?

## 8071FSV - 8071FSC

(TP) Ø 120 H 75 cm  
(T) Ø 140 H 75 cm

## 8074FV

(OK) L 260 P 120 H 75 cm  
(OX) L 300 P 120 H 75 cm  
(RZ) L 240 P 120 H 75 cm  
(RK) L 300 P 120 H 75 cm

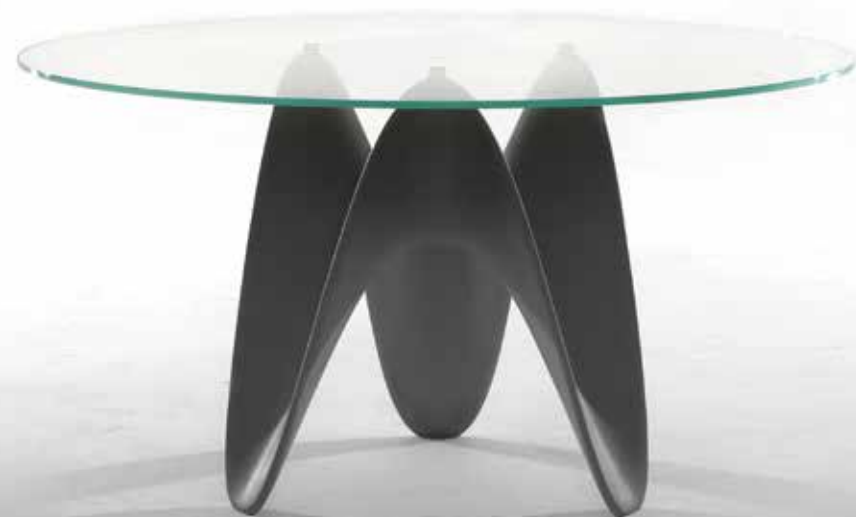

Gaya 8071FSV  
Tecnoril® matt white base (01);  
extra-clear transparent glass top  
(V\_100)





Gaya 8074FV  
Tecnoril® matt roux base (43);  
transparent fumé glass top (V\_85)

# imperial

design\_Studio 28

Il tavolo Imperial si sviluppa come uno stelo a base rotonda: a terra ispessisce e si alleggerisce verso l'alto, creando un equilibrio perfetto tra spazi vuoti e materia. L'agglomerato di marmo della base è lucido, splende nell'appaiarsi ai piani in vetro temperato.

Imperial table grows like a round-based stem: it thickens on the ground, and gets thinner as it goes up, shaping a perfect balance between empty spaces and material. The shiny cultured marble - the base - marries different finishes of tempered glass - the top.

Имперский стол растет как стебель с овальным основанием: он утолщается у основания, и становится тоньше при движении вверх, формируя идеальный баланс между пустыми пространствами и материалом. Блестящий искусственный мрамор — основание — объединяет в себе различные отделки из закаленного стекла и керамогранита поверхности.

8010FSV - 8010FSC

(PEL) L 180 P 105 H 75 cm  
(EL) L 200 P 105 H 75 cm  
(L) L 220 P 120 H 75 cm



Imperial 8010FSC  
Fixed table with agglomerate  
glossy white base (501);  
Statuario Altissimo base (V01P)



# light

design\_Studio Archirivolto

Light è leggerezza, essenzialità e purezza di forma. Funzionale sino a dove si può estendere, la sua ampiezza variabile lo rende ideale per ospitare molti commensali, ed offrire in ogni caso un senso di leggerezza e modernità.

Light is essential, pure and minimal. Its functionality goes as far as its extensions, its wideness makes it ideal for numerous guests, to offer a sense of lightness and modernity.

LIGHT — существенный, чистый и минималистичный. Его функциональность заключается в его расширениях, а его ширина делает его идеальным для многочисленных гостей, предлагая ощущение легкости и современности.

8065FSV - 8065FSL - 8065FSC

(P) L 140/185 P 90 H 75  
(A) L 160/205/250 P 90 H 75  
(G) L 180/225/270 P 90 H 75



Light 8065FSV  
Matt anthracite varnished aluminum structure (64);  
frosted extra-clear anthracite glass top (V\_664)



**Light 8065FSV**  
Extendible table:  
Matt beige aluminum structure (36);  
extra-clear frosted beige top (V\_636)  
with beige extension

**Light 8065FSC**

Matt white varnished aluminum structure (01);  
white ceramic glass top (V\_01C);  
polymeric extensions [aluminum/HPL laminate];  
matt white (01)



Una delle migliori qualità del design, risiede nella sua infinitezza: la tecnologia migliora, e aumentano così le scelte disponibili per realizzare i propri prodotti nella migliore delle maniere. Un concetto già in uso, come quello di tavolo allungabile, può così variare, e rinnovarsi e risultare sempre contemporaneo. In Light, abbiamo cercato di raggiungere precisamente questo risultato.

One of interior design's best quality, is its infiniteness: technology gets better, and the consequent available choices grow, to build your products in the best possible way. An already used concept, such as that of an extendible table, can thus vary, and renovate and end up to be contemporary. This is the result we looked for, for our Light.

Одно из главных достоинств дизайна заключается в его бесконечности: технологии совершенствуются, и появляется больше доступных способов сделать собственную продукцию ещё лучше. Такой принцип уже используется, как в случае с раздвижным столом, который может меняться, обновляться и оставаться всегда современным. С моделью Light мы постарались добиться именно такого результата.



# manhattan

design\_Studio 28

Manhattan, un tavolo dalla linea profondamente elegante ed intramontabile, con una solida base in acciaio inox, un telaio cromato e piani in legno, marmo, vetro o gres porcellanato. Un tavolo capace di trasportarti immediatamente nella metropoli più bella del mondo.

## 8051FSV - 8051FLM - 8051FSL - 8051FSC

(A) L 200 P 100 H 75 cm  
(G) L 250 P 120 H 75 cm  
(Z) L 300 P 120 H 75 cm

## 8051FSM

(A) L 200 P 100 H 75 cm  
(G) L 250 P 120 H 75 cm

Manhattan, a table with a deeply elegant, ever-green line; a solid stainless steel base, a chromed frame, and wood, marble, glass tops and porcelain stoneware. This table will bring you right to the most amazing metropolis in the world, in the blink of an eye.

## 8051

(P) L 160/240 P 90 H 75 cm  
(A) L 180/260 P 90 H 75 cm  
(G) L 200/300 P 100 H 75 cm  
(D) L 200/300 P 110 H 75 cm

Manhattan — стол с глубоко элегантной, вечнозеленой линией; твердое основание из нержавеющей стали, хромированный каркас, поверхности из дерева, мрамора, стекла и керамогранита. Этот стол приведет вас прямо к самому удивительному мегаполису в мире — в мгновение ока.

Manhattan 8051FSL  
Chromed metal base (72);  
Canaletto walnut top (14)



Manhattan 8051FSM  
Chromed metal base (72);  
glossy black Marquinia marble top (M\_102)







Manhattan 8057FLM  
Fixed table:  
Carbon grey metal structure (10);  
solid Canaletto walnut top (LM\_14)

# rizoma

design\_Angelo Tomaiuolo

Il morbido calore del legno incontra in Rizoma la fantasia, l'estro e la tecnica del design. Un'idea che riesce a formare un connubio tra il più naturale e ricercato dei materiali, e la tecnica più avanzata. Una base in legno curvato che si svolge a spirale, e sorregge il piano in vetro.

Wood's soft heat meets our designer's fantasy, imaginative mind and technique: Rizoma. The idea managed to combine one of Nature's most precious materials, and the most advanced working techniques. This curved wood base swirls and spins up to the top, holding a light and precious glass top.

Мягкий вереск древесины удовлетворяет фантазии нашего дизайнера, творческий ум и технологию: Rizoma. Этой идее удалось объединить один из самых благородных природных материалов и самые передовые рабочие технологии. Это основание из гнутого дерева закручивается и раскручивается к верхней части, удерживая легкое и изысканное стекло или поверхность из керамогранита.

## 6907FSV

(T) Ø 140 H 75 cm

(P) Ø 160 H 75 cm

(E) L 220 P 120 H 75 cm

## 6907FSV

(T) Ø 140 H 75 cm

(E) L 220 P 120 H 75 cm



Rizoma 6907FSV  
Solid Canaletto walnut base (LM\_14);  
Portoro marble porcelain  
effect top (V85P)



Rizoma 6907FSV  
Solid Canaletto walnut base (LM\_14);  
transparent grey fumé glass top (V\_85)



# roma

design\_Angelo Tomaiuolo

Geometrico, preciso ed elegante, Roma si poggia su gambe in marmo, o legno; la geometria alimenta la forza naturale dei materiali, riuscendo a scomporre gli spazi occupati, e a portare l'attenzione alla leggerezza delle linee.

Geometric, precise and elegant: Roma stands on marble, or wooden legs; its geometry feeds the materials' natural strength, deconstructing the occupied spaces, and drawing attention to the table's light lines.

Геометрический, аккуратный и элегантный: Рома стоит на мраморных или деревянных ножках; его геометрия питает естественную силу материалов, преобразовывая занимаемые им пространства и привлекая внимание к легким линиям стола.

8068

(N) L 160 P 93 H 75 cm  
(S) L 180 P 93 H 75 cm  
(A) L 200 P 110 H 75 cm  
(G) L 250 P 110 H 75 cm



Roma 8068  
Knotty natural oak base (13);  
Knotty natural oak top (13)



**Roma 8068**  
Knotty natural oak base (13);  
Knotty natural oak top (13)



Roma 8068  
Matt Carrara marble base (M\_101);  
heat-treated dark oak top (16)



Roma 8068  
Matt white Carrara marble base (M\_101);  
heat-treated dark oak top (16)

Tokyo è disponibile nella versione fissa, o allungabile con binario in alluminio e piano in vetro, vetro ceramizzato, legno o marmo. La base in agglomerato di marmo, la cui curvatura crea un forte dinamismo, è disponibile con una finitura RAL, un dettaglio che permette di personalizzare a piacere la propria sala da pranzo. Le combinazioni che si possono creare sono molteplici, e il design risulta ad un tempo contemporaneo e classico, grazie soprattutto all'innovativo piano allungabile in legno.

Tokyo, available both in the fixed, and the extendible version, with an aluminum guide bar, and glass, ceramic, wood or marble tops. The legs are made out of cultured marble, and their strongly dynamic lines can be completed by a RAL finishing, a detail that allows you to customize your own dining room. You can create numerous combinations, and Tokyo's design will always result both contemporary and classic, especially because of the wooden extendible top.

В наличии классическая и раздвижная модели Tokyo с направляющей из алюминия. Столешница может быть выполнена из стекла, керамического стекла, дерева или мрамора. Изогнутые линии основания из мраморной крошки придают изделию эффект невероятной динамичности. В наличии модели с отделкой по цветовой шкале RAL, что позволит вам разнообразить цветовую гамму обеденной зоны в соответствии со своими вкусами. Огромный выбор сочетаний, одновременно классический и современный дизайн, обеспечиваемый, в первую очередь, раздвижной столешницей из дерева.

#### 6951FSV

(FP) L 160 P 90 H 75 cm  
(FA) L 180 P 90 H 75 cm  
(FG) L 200 P 100 H 75 cm  
(A) L 200 P 100 H 75 cm  
(G) L 250 P 120 H 75 cm  
(Z) L 300 P 120 H 75 cm

#### 6951FSL - 6951FV

(A) L 200 P 100 H 75 cm  
(G) L 250 P 120 H 75 cm  
(Z) L 300 P 120 H 75 cm

#### 6951FL

(G) L 300 P 110 H 75 cm  
(A) L 250 P 110 H 75 cm  
(P) L 200 P 110 H 75 cm  
(S) L 180 P 93 H 75 cm  
(N) L 160 P 93 H 75 cm

#### 6951FLM

(A) L 200 P 106 H 75 cm  
(G) L 250 P 106 H 75 cm  
(Z) L 300 P 120 H 75 cm

#### 6951FSM

(A) L 200 P 100 H 75 cm  
(G) L 250 P 120 H 75 cm

#### 6951FV

(FP) L 160 P 90 H 75 cm  
(FA) L 180 P 90 H 75 cm  
(FG) L 200 P 100 H 75 cm

#### 6951

(P) L 160/240 P 90 H 75 cm  
(A) L 180/260 P 90 H 75 cm  
(G) L 200/300 P 100 H 75 cm



Tokyo 6951  
Glossy white cultured marble base (501);  
knotty natural oak top (13);  
solid wood elements





**Tokyo 6951**  
Glossy white cultured marble base (501);  
knotty natural oak top (13); solid wood  
elements



Tokyo 6951FV  
Fixed table:  
Glossy white structure (501);  
Statuario Altissimo top (VO1P)

Tokyo 6951FL  
Glossy champagne cultured marble base (560);  
heat-treated dark oak top (16)



Tokyo 6951FSL  
Glossy black cultured marble base (502);  
Canaletto walnut top (14)



Tokyo 6951  
Grey/Beige RAL coloring base;  
polished aluminum guide-bar (71);  
transparent, bronzed glass top (V\_84)



Il legno massello, naturalmente caldo ed accogliente, si rinfresca nelle nuove versioni disponibili. Il suo design, ormai divenuto parte della storia di Tonin Casa, matura e rinasce, grazie ad uno studio accurato dei materiali e delle nuove tecniche di lavorazione. Il legno massello, in particolare, conferisce ulteriore spinta estetica e durevolezza: un'unica tavola, calda e resistente, elegante e classica sopra alla base in stile contemporaneo.

This solid wood, naturally warm and welcoming, gets refreshed by the new versions available. Its design has now become part of Tonin Casa's history, aging, but changing, thanks to the materials and our new techniques.

Массив дерева, который уже сам по себе является естественно теплым и создающим уют, обновляется в новых моделях. Дизайнерские изыскания с использованием этого материала, которые стали частью истории мебельного дома Tonin Casa, совершенствуются и обновляются в процессе тщательного изучения свойств материалов и новых технологий обработки. Такой материал, как массив дерева придает дополнительные эстетические преимущества и долговечность уникальному столу, теплому и прочному, с элегантной классической столешницей, которая установлена на современном стильном основании.



# ventaglio

design\_Nicola Tonin

Concepito in Italia e composto di sole materie prime italiane, Ventaglio offre un connubio ideale di sapienza artigiana e qualità. La base del tavolo, e principale caratteristica di questo prodotto, è realizzata in metallo curvato e verniciato in diverse colorazioni. Il piano, allungabile o fisso, è disponibile in vetro, vetro ceramizzato e legno. L'eleganza del design si rivela al suo massimo, nella versione allungabile in legno.

Ventaglio was conceived in Italy, and made out Italian raw materials. It offers the perfect combination of craftsmanship and quality. The curved metal legs, main characteristic of this table, can be varnished with different colors. Glass, tempered glass and wooden tops are available, both fixed and extendible. Uncover the elegance of its design with the extendible, wooden version. Solid wood provides further endurance and beauty: a whole board, warm and resistant, elegant and classic, standing out, above the contemporary base.

Стол Ventaglio создан полностью по итальянскому проекту и с использованием первоклассных итальянских материалов. Это идеальный пример сочетания мастерского выполнения и качества. Основание стола, которое выступает ключевым элементом изделия, изготовлено из гнутого металла с цветным покрытием по выбору. В наличии модели столешницы, включая раздвижную, из стекла, керамического стекла или дерева. Раздвижная модель из дерева выступает максимальным проявлением элегантности и дизайнерского потенциала этого предмета интерьера.

## 8011FV - 8011FV

(P) L 160 P 90 H 75 cm  
(A) L 180 P 90 H 75 cm  
(G) L 200 P 100 H 75 cm

## 8011

(P) L 160/240 P 90 H 75 cm  
(A) L 180/260 P 90 H 75 cm  
(G) L 200/300 P 100 H 75 cm

## 8011FL

(D) L 300 P 110 H 75 cm  
(G) L 250 P 110 H 75 cm  
(A) L 200 P 110 H 75 cm  
(S) L 180 P 93 H 75 cm  
(N) L 160 P 93 H 75 cm



Ventaglio 8011  
Shaped metal base: matt white (01);  
knotty natural oak top (13);  
solid wood elements



Ventaglio 8011  
Shaped metal base: matt white (01);  
knotty natural oak top (13);  
solid wood elements





Ventaglio 8011FL  
Shaped metal base: stone bronze (83);  
Canaletto walnut top (14)

Ventaglio 8011  
Extendible table:  
matt black shaped metal base (02);  
anodized aluminum guide-bar (32);  
black ceramic glass top (V\_02C)



Il legno, le sue venature, la freschezza del colore: la materia. Le linee continue e i meccanismi di allungamento precisi e funzionali: la lavorazione. Ventaglio ha tutte le caratteristiche di un protagonista, ossia tecnica e bellezza.

Wood, its grain, its color's freshness: material. Continual lines; precise and functional extensions: its manufacture. Ventaglio owns every single characteristic a protagonist should have: technique and beauty.

Дерево, его своеобразная текстура и свежесть аромата – это Материя. Непрерывные линии и точные механизмы для практичного удлинения стола – это Мастерство. Стол Ventaglio обладает всем необходимым, чтобы стать главным героем интерьера, как в техническом, так и в эстетическом плане.



# wave

design\_Studio 28

Wave è il risultato di una lunga serie di studi e pensieri su diverse tecniche di lavorazione e materiali innovativi. L'utilizzo del Baydur® ha permesso che la base andasse ad imitare perfettamente la forza ed il movimento di un'onda; inversamente, il piano viene sostenuto da quell'onda, placandola e ridefinendola: trasformandola da puro movimento a stasi.

WAVE is the result of long and diverse techniques, based on how to work with different and innovative materials. We decided to use Baydur, a material that allowed the base to perfectly imitate a wave's strong movements. To counter-balance, the top was thought to look as static as possible, a line to appease and redefine the wave. It starts as pure movement; it ends as stasis.

WAVE является результатом применения длительных и разнообразных технологий, основанных на том, как работать с различными и инновационными материалами. Мы решили использовать Baydur, материал, который позволил основанию идеально имитировать сильные движения волны. Для уравновешивания предполагалось, что поверхность будет выглядеть как можно более статической, а линия — умиротворяющей и переопределяющей волну. Начинается как чистое движение; завершается, как статика.

## 8014FLM

(A) L 200 P 106 H 75 cm  
(G) L 250 P 106 H 75 cm  
(Z) L 300 P 120 H 75 cm

## 8014FSM

(FP) L 200 P 100 H 75 cm  
(FA) L 250 P 120 H 75 cm

## 8014FRC - 8014FV

(FP) L 160 P 90 H 75 cm  
(FA) L 180 P 90 H 75 cm  
(FG) L 200 P 100 H 75 cm  
(FD) L 200 P 110 H 75 cm

## 8014FSC

(FP) L 200 P 100 H 75 cm  
(FA) L 200 P 120 H 75 cm  
(FD) L 300 P 120 H 75 cm  
(EL) L 200 P 105 H 75 cm  
(ER) L 220 P 110 H 75 cm

## 8014FSV

(EL) L 200 P 105 H 75 cm  
(ER) L 220 P 110 H 75 cm

## 8014FSL

(FP) L 200 P 100 H 75 cm  
(FA) L 250 P 120 H 75 cm  
(FG) L 300 P 120 H 75 cm

## 8014

(P) L 160/240 P 90 H 75 cm  
(A) L 180/260 P 90 H 75 cm  
(G) L 200/300 P 100 H 75 cm  
(D) L 200/300 P 110 H 75 cm

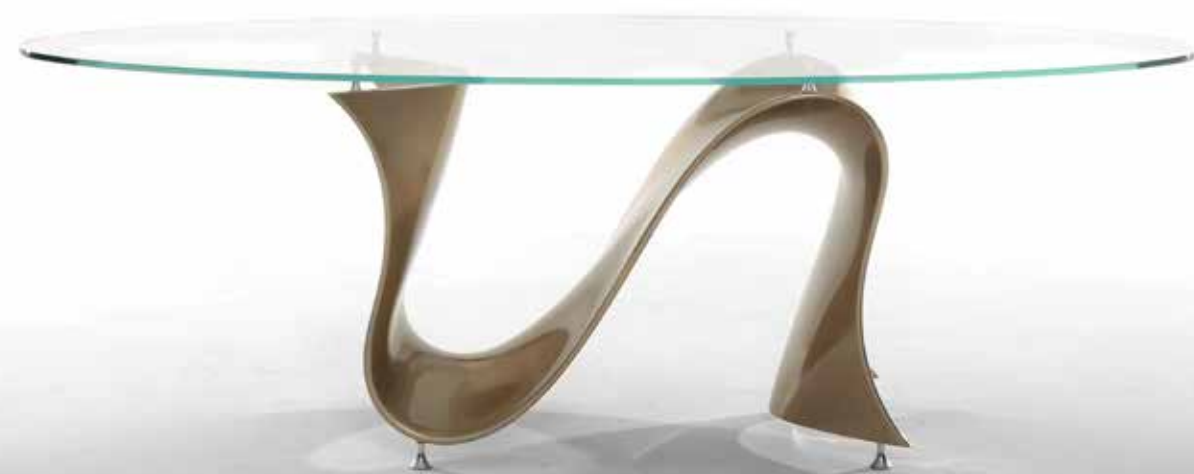

**Wave 8014**  
Glossy beige Baydur® base (536);  
polished aluminum guide-bar (71);  
extra-clear transparent glass top (V\_100)





**Wave 8014**  
Extendible table:  
glossy black Baydur® base (502);  
polished aluminum guide-bar (71);  
transparent, bronzed glass top (V\_84)



Wave 8014FSC  
glossy white Baydur® base (501);  
Statuario Altissimo top (VO1P)

Wave 8014  
Glossy white Baydur® base (501);  
polished white guide-bar (01);  
white ceramic glass top (V01C)





Wave 8014FLM  
Gun metal Baydur® base (12);  
solid walnut top (LM\_14)



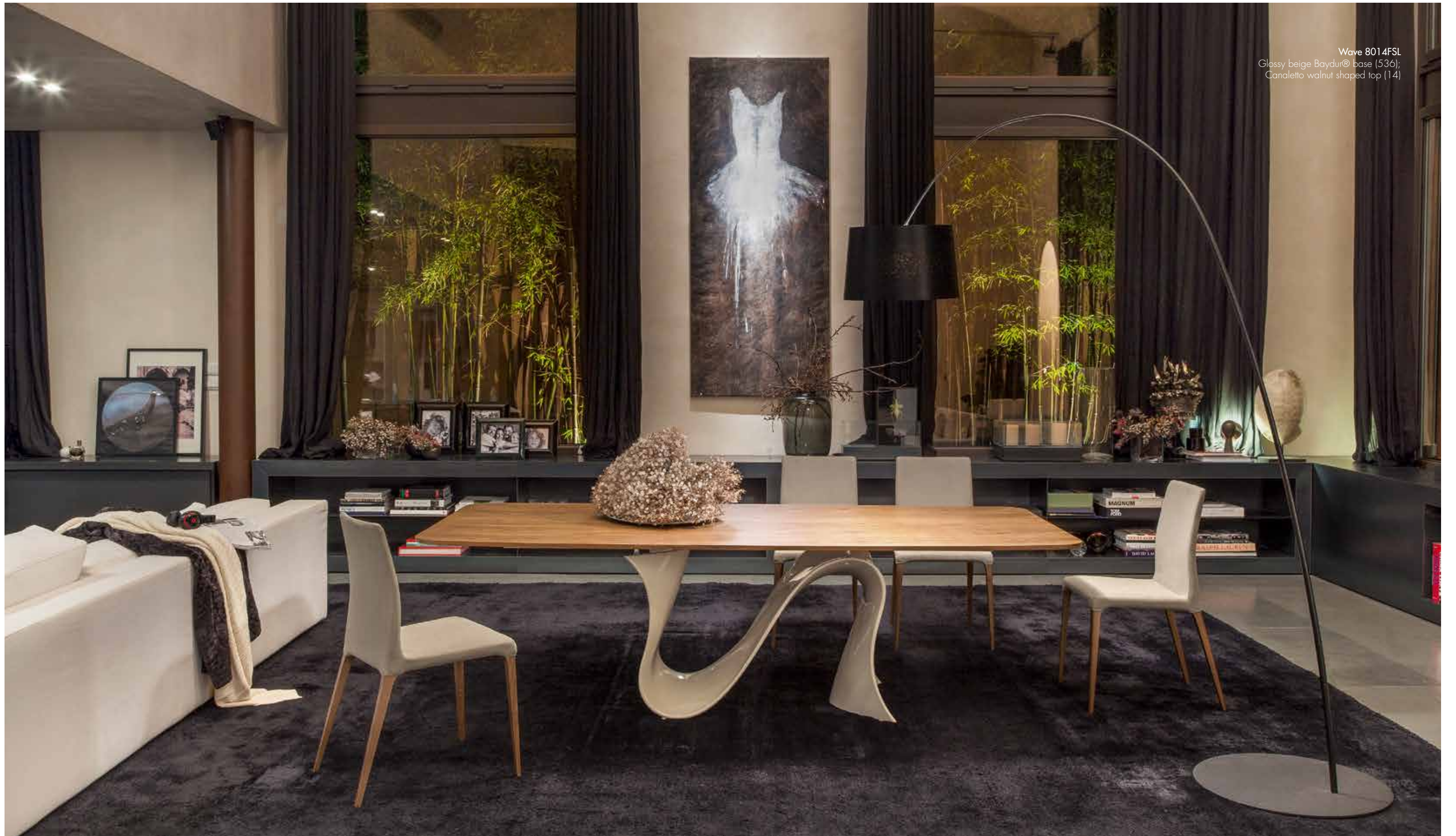

Wave 8014FSL  
Glossy beige Baydur® base (536);  
Canaletto walnut shaped top (14)

Combinare materiale e colore, per esaltarne la forma: il Baydur® di Wave si tinge di beige, un tono pacato e dolce, che ne addolcisce la linea già di per sé morbida. La luce si rifrange sulle curve della base, evidenziando la precisione con cui il materiale è stato lavorato, e dando corpo e presenza alla caratteristica più peculiare e innovativa di questo tavolo.

Combining material and color, to bring out the shape: Wave's Baydur® goes beige, a quiet and sweet shade, to sweeten its already soft line. Light hits the curves of the base, highlighting the precision it took to work on this material, and breathing life into the most peculiar and innovative characteristic of this table.

Сочетание материала и цвета, чтобы подчеркнуть форму: il Baydur di Wave окрашен в бежевый, спокойный и тёплый тон, который смягчает уже и так нежную линию. Свет преломляется на изгибах основания, подчеркивая точность, с которой был обработан материал, и придает особенный, новаторский вид столу.



# ventaglio

design\_Nicola Tonin

Ventaglio è una consolle allungabile, che può diventare un tavolo molto spazioso. La base in metallo sagomato laccato ben si adatta ai piani in effetto legno. Basi di un bianco opaco, nero opaco o bronzo pietra si abbinano perfettamente ai piani in noce canaletto, rovere scuro con effetto a rilievo e bianco opaco.

Ventaglio is an extendible console table, that can become a quite large dining table. The lacquered metal base is perfect for the wood covered tops. Matt white, matt black, or stone bronze bases perfectly match the Canaletto walnut, dark embossed oak and the matt white tops.

Ventaglio выполнена в виде раздвижной консоли, которая превращается в просторный стол. Основание из фасонного металла с лакированным покрытием идеально подходит для столешниц под дерево. Основания белого, черного матового или бронзового цвета отлично сочетаются со столешницами из черного ореха, темного дуба с рельефной текстурой или с белой матовой отделкой.

6509

(P) L 100 P 50/200 H 75 cm  
(A) L 100 P 50/300 H 75 cm



Ventaglio 6509  
Table/Console table:  
matt black shaped metal base (02);  
wood-like Canaletto walnut effect (PML\_05)



Ventaglio 6509  
Table/Console table:  
matt black shaped metal base (O2); wood-like  
Canaletto walnut effect (PML\_05)

Il ventaglio alla base della consolle si apre agilmente, con un meccanismo semplicissimo e che garantisce un effetto estetico ideale. Le gambe ruotano, il ventre del piano si allunga e viene sostenuto nella zona centrale da due sostegni tubulari estraibili. La possibilità di ottenerne un tavolo abbastanza grande da ospitare anche otto persone non toglie alcunché al design di Ventaglio, una consolle studiata per apparire sempre unica, leggera ed elegante.

The fan-like base easily opens, thanks to a simple mechanism that also provides an ideal aesthetic effect. The base rotates, the top widens while being supported by two extractable legs. Being able to have a table that is big enough to comfortably sit up to eight people does not affect Ventaglio's design, at all: its shapes are unique, light and elegant.

Основание в форме веера открывается при помощи простого механизма, обеспечивающего безупречный эстетический эффект. Поворачивая ножки, веер раскрывается и поддерживается в центре двумя съёмными трубками. Получается большой стол, даже на восемь человек, что ни в коей мере не сказывается на дизайнерской привлекательности Ventaglio, уникальной, легкой и изысканной.





# adria

design\_Studio Tonin Creatives

Sedia dalla linea semplice e snella, con una struttura in metallo cromo nero, pelle fiore e pelle nabuk, utilizzabili per il rivestimento, creano un effetto delicato ed elegante.

This is an easy and simple chair, with a black chrome metal structure. It can be covered in leather, eco-leather, grain leather and Nubuk leather, to create a delicate and elegant effect.

Это легкий и простой стул с черной хромированной металлической конструкцией. Он может быть покрыт кожей, эко-кожей, зернистой кожей и нубуком, чтобы обеспечить изысканный и элегантный эффект.

**8041**

L 46 P 55 H 105/47

**8041A**

L 46 P 55 H 105/47



**Adria 8041A**  
Fully covered chair:  
ash grey grain leather (PF\_27)

Una seduta, semplice ed efficace, e pure arricchita dal delicato effetto a fiore. Le pieghe si allargano dal centro, aprendo lo spazio verso le rifiniture ai bordi. Un piccolo bottone, sapientemente cucito, è sufficiente ad esaltare il lato dinamico di una sedia estremamente elegante e raffinata.

A simple and effective chair, enriched by the delicate flower-like effect. Its folds widen starting from the middle, making room for the external stitching. A small button, wisely sewed, is enough to enhance this extraordinarily elegant and refined chair's dynamism.

Простой на первый взгляд стул, необычно практичный и обогащенный стяжкой в виде нежного цветка. Складки расходятся от центра, открывая пространство для отделки по краям. Небольшая умело вшитая пуговица стяжки сразу же подчеркивает всю динамичность этого невероятно элегантного стула с изысканным дизайном.





# aragona

design\_Studio Tonin Creatives

Sedia con una struttura in legno frassino tinto noce, rovere scuro termotrattato e rovere naturale. I diversi rivestimenti, in pelle, pelle fiore, pelle nabuk, eco-pelle e diversi tipi di tessuto permettono di accostare questa sedia a diversi tipi di tavolo, per un effetto contemporaneo ed intramontabile ad un tempo.

A chair with an ash wood-finished Canaletto walnut, heat-treated dark oak, or natural oak structure. The different upholsteries – leather, grain leather, Nubuk leather, eco-leather and different fabrics – allow you to sit this chair next to very different tables, for a contemporary, or rather classic result.

Стул с несущей структурой из ясеня, цвет: орех, темный термообработанный дуб или натуральный дуб. Обивка на выбор (кожа, кожа первой категории, нубук, искусственная кожа и разные виды тканей) позволяет сочетать стул со столами разных типологий и форм, создавая современный или неподвластный времени классический стиль оформления.

7209

L 46/38 P 55 H 96/48



Aragona 7209  
Ash wood structure: painted natural oak (17);  
covering: brick red pied-de-poule fabric (TP\_03)

Aragona 7209  
Ash wood structure: painted dark  
oak heat-treated (16);  
covering: deep blue  
Vega velvet (T10V)



Accostiamo qui la forza del legno, slanciato nelle gambe sottili, alla texture particolare e moderna del tessuto. Combiniamo i dettagli, aumentiamo la forza del materiale con la precisione della lavorazione, e concediamo ad Aragona di occupare uno spazio tutto suo, pur riuscendo a creare gli abbinamenti più disparati.

Here, we put our wood's strength next to the chair's thin legs, to its modern and peculiar texture. We combine details, we augment the material's natural strength thanks to our precise manufacture. We give Aragona the chance to fill its own space, yet giving you the chance to create the most diverse matches.

Ко всему следует добавить прочность дерева изящных тонких ножек стула и особенности текстуры современных тканей. Мы сочетаем детали, увеличиваем прочность материалов благодаря точности выполнения. Поэтому модель Агагона занимает свое особенное место в интерьере, одновременно создавая отличные сочетания в самых разных стилях.



# aria easy

design\_Studio 28

Aria Easy è una sedia impilabile e leggera, che vanta una scocca in stampato polimerico, ed una struttura in metallo laccato o cromato. La lievità è la sua caratteristica fondamentale, assieme alle linee morbide e semplici, che la rendono abbinabile a svariati contesti.

Aria Easy is a light, stackable chair, build with a polymeric moulded body, and a chromed or lacquered metal structure. Its fundamental characteristic is lightness, and it combines with simple and soft lines that make it perfect for several different atmospheres.

Aria Easy — легкий, складываемый стул, созданный с полимерным формованным каркасом, а также хромированной или лакированной металлической конструкцией. Его основной характеристикой является легкость, и это сочетается с простыми и мягкими линиями, которые делают его идеальным для различных обстановок.

7204

L 50 P 50 H 84/46



**Aria Easy 7204**  
Structure: chromed metal round tube (72);  
seat: transparent fumé polycarbonate (85)



Aria Easy 7204  
Stackable chair:  
glossy white polymeric moulded body (501);  
same-color stucture (BT\_01)

# charm

design\_Studio Tonin Creatives

Sedia dagli angoli smussati e lievi, Charm si contraddistingue per l'imbottitura in gomma ad alta densità, un materiale che crea sedute estremamente confortevoli e durevoli. Si riveste di tutte le pelli disponibili nel campionario Tonin Casa, nella massima varietà disponibile di colorazioni ed effetti.

Charm's smooth and light angles are covered in a high-density foam: this material is used to create extremely comfortable and lasting chairs. Its covering comprehends every leather available in Tonin Casa's sampling.

Плавные и легкие углы Charm покрыты пеной высокой плотности: этот материал используется для создания чрезвычайно удобных и прочных стульев. Его покрытие охватывает каждый вид кожи, доступный в образцах Tonin Casa.

7216

L 44 P 52 H 97/49



Charm 7216  
Fully covered chair:  
mud eco-leather (S\_51)

Charm 7216  
Fully covered chair:  
dark brown leather (S\_70)



# charonne

design\_Studio 28

Sedia con struttura in metallo cromato, su cui poggia la seduta creata con uno stampo di poliuretano. La forza del materiale si unisce alla verticalità di Charonne, che denota eleganza e carattere. Rivestita in tessuto, pelle o eco-pelle, è in grado di accompagnare ogni ambiente, rendendosi allo stesso tempo protagonista.

A chromed metal structure holds a foamed polyurethane chair. The material's strength marries Charonne's verticality, and calls for elegance and pride. Charonne is covered in fabric, leather, or eco/leather; it fits in every room, both as a mild presence, and as a protagonist.

Хромированная металлическая конструкция удерживает стул из пенополиуретана. Прочность материала объединяется с вертикальным положением Charonne, призывая к элегантности и гордости. Charonne покрыт тканью, кожей или эко-кожей; он вписывается в любую обстановку, как в качестве скромного элемента, так и в качестве главного героя.

7265

L 45 P 52 H 108/48



Charonne 7265  
Chromed metal structure (72);  
cream Nubuck leather covering (PN\_05)



# felix

design\_Nicola Tonin

Sedia con base in legno e seduta rivestita in pelle, o eco-pelle. Le gambe smussate spingono verso il centro della seduta, ed il legno così si abbina perfettamente, salendo, con le pieghe create ad arte sullo schienale: una linea continua che ricerca verticalità ed equilibrio.

This chair has a wooden base, and a leather. Or eco-leather covered seat. The smooth legs push towards the seat's focal point, allowing wood to perfectly marry the foldings of the back: a continuous line, reaching for verticality and balance.

Этот стул имеет деревянное основание и кожу. Или сиденье, покрытое эко-кожей. Ровные ножки направлены к центральной точке сидения, позволяя дереву идеально объединять складки на спинке: непрерывная линия, стремящаяся к вертикальному положению и балансу.

7280

L 53 P 58 H 78/47



Felix 7280

Ash wood structure: painted Canaletto walnut (14);  
seat covered in pink grain leather (PF\_06)

# hole

design\_Studio Archirivolto

Hole è una sedia stampata in polipropilene, un materiale che permette l'unione di sostenibilità ecologica e resistenza. La struttura in metallo laccato o cromato ben si abbina ai colori disponibili per la scocca: bianco, sabbia, grigio blu cadetto, rosso mattone e fango. Una seduta ideale sia per un ambiente cucina moderno e raffinato, sia per l'ufficio.

Hole is a polypropylene molded chair. This material allows to put durability and eco-sustainability together. The lacquered or chromed metal structure perfectly coordinates with the upholsteries. These latter are available in white, cadetto blue grey, brick red, sand and mud. An ideal sit for both a modern and refined kitchen, and for your office.

Hole — стул, сформованный из полипропилена. Этот материал позволяет сочетать долговечность и экологическую устойчивость. Лакированная или хромированная металлическая конструкция отлично сочетается с обивками. Последние доступны в белом, серо-голубом цвете, а также в цвете красного кирпича, песка и глины. Идеальный элемент мебели как для современных и изысканных кухонь, так и для вашего офиса.

7207

L 45 P 56 H 86/45



**Hole 7207**  
Chromed metal structure (72);  
seats: matt sand (18); matt mud (51)



5

**Hole 7207**  
Structure: carbon grey structure (10);  
chromed metal (72) and white metal (01).  
Seats: matt anthracite (64); matt white (01);  
brick red (22); matt mud (51);  
cadetto blue-grey (08) and matt sand (18)



I dettagli di Hole, in penombra, vengono esaltati dalla luce che ne attraversa lo schienale. I contorni morbidi e piacevoli, uniti agli effetti di luce ed ombra dati dal colore e dalle gambe sottili e moderne si uniscono centralmente, come in un bizzarro punto di fuga prospettico.

A soft light can enhance Hole's figure, just by passing through its back. Its smooth, enjoyable profile, mixed with the light shadows brought by colors, shapes and legs, all reunite centrally, forming a bizarre vanishing point.

Детали стула Hole, словно скрытые полутьмой, отлично выделяются игрой света, проходящего сквозь спинку. Мягкие приятные контуры и игра света, образуемая расцветкой и тонкими ножками современного дизайна воссоединяются в центре, словно в причудливой перспективной точке.



# kosmos

design\_Studio Tonin Creatives

Una sedia, o una poltroncina, il cui punto di forza è lo schienale: costruito in acciaio armonico, oscillante, è una delle punte di diamante del design. La tecnica in questo caso spinge verso la comodità, verso un uso il più possibile confortevole e piacevole. Esteticamente, si presenta nelle versioni con e senza braccioli, diventando così sia capo-tavola, che sedia; il rivestimento è disponibile in una versione standard, ed in una con trapuntatura a rombi, lavorazione che esalta ulteriormente lo slancio dello schienale.

Coming both as a chair, or as a small armchair, Kosmos finds its strenght in its backrest: it was built in oscillating, harmonic steel, the crown jewel of our chair design. The technique we used, aims in this case at the most pleasant and cozy comfort. It comes with, or without armrests; it has a standard covering, and a rhombus patternes covering. The latter truly extols the backrest's momentum.

Как в виде стула, так и небольшого кресла, KOSMOS обретает свою силу в спинке: она была сконструирована из осциллирующей, гармонической стали — жемчужины нашего дизайна стульев. Техника, которую мы использовали, нацелена в этом случае на самый приятный и уютный комфорт. Он поставляется с или без подлокотников; он имеет стандартное покрытие, и покрытие с узором «ромбы». Последнее действительно усиливает привлекательность спинки.

**7286**

L 48 P 51 H 90/48

**7286B**

L 60 P 51 H 90/48

**Kosmos 7286**  
Black chrome structure (76);  
deep-blue Vega velvet covering (T10V)



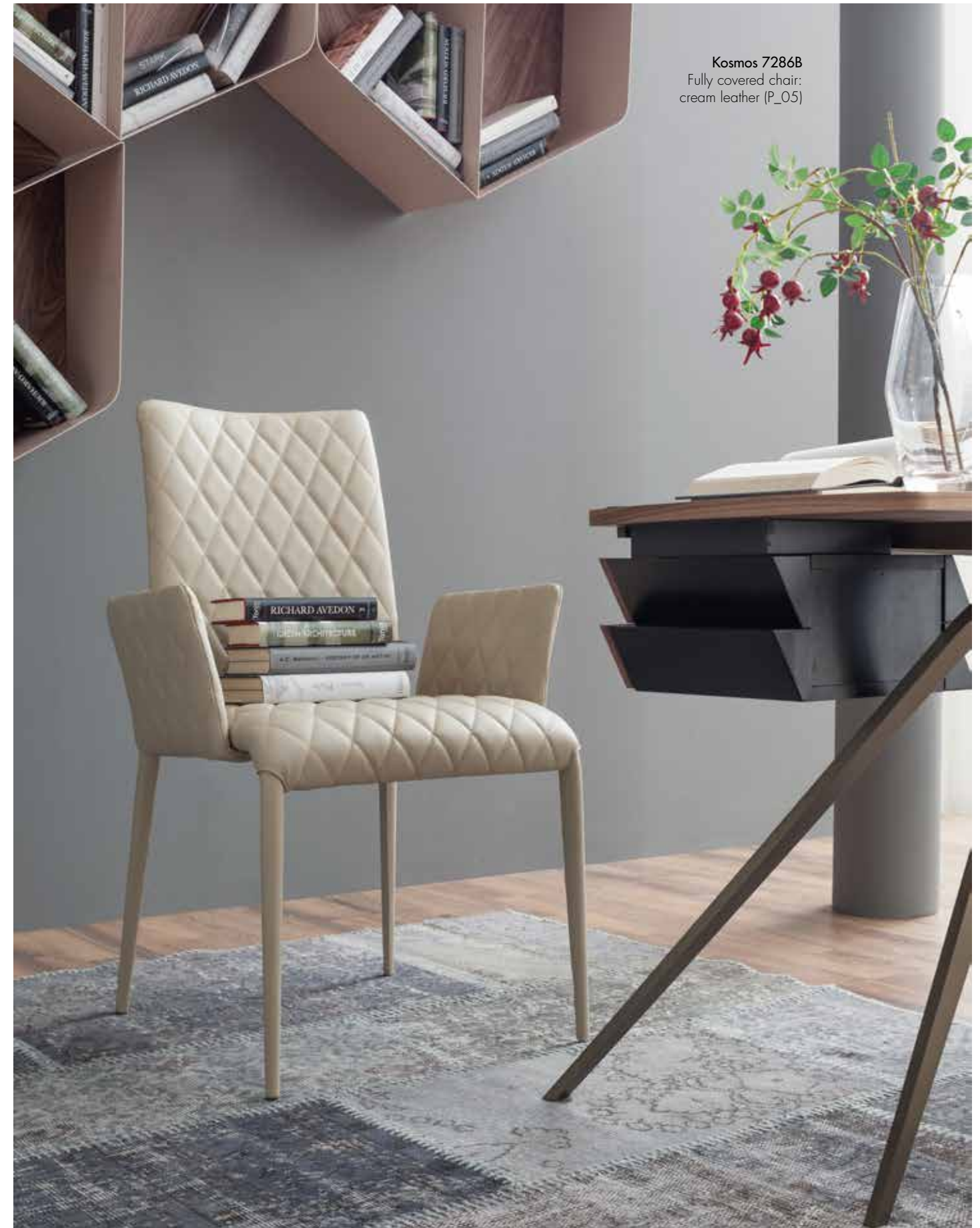

Kosmos 7286B  
Fully covered chair:  
cream leather (P\_05)

# lisetta

design\_Angelo Tomaiuolo

Sedia in poliuretano schiumato, materiale eccellente per la creazione di forme particolari, e di sedute estremamente confortevoli. Lisetta è leggera e spigliata, e si colora di tutte le nostre pelli, oltre che dei tessuti verbena e ninfea: è perfetta in ogni dove.

This is a foamed polyurethan chair, a material that allows peculiar shapes and extremely comfortable chairs. Lisetta is light and breezy, colored with our leathers, our Verbena fabric, and our Ninfea fabric: it is simply perfect everywhere.

Этот стул выполнен из вспененного полиуретана, материала, который обеспечивает своеобразные формы и очень удобные кресла. Lisetta — легкий и свежий, украшенный нашей кожей и эко-кожей: он просто идеален везде.

7200

L 51 P 57 H 103/46



Lisetta 7200  
Fully covered chair:  
powder leather (PF\_47)







Lisetta 7200  
Fully covered chais:  
dark brown leather (P\_70);  
sage leather (P\_35)



# madeleine

design\_Studio 28

Sedia dalla forma resa particolare per lo schienale: una curva rientra docilmente ad accompagnare la seduta verso il basso, movimentando le forme geometriche di Madeleine. Il rivestimento in cuoio ne esalta l'eleganza, e la versione con braccioli ne è la massima espressione.

The shaped backrest is what makes this chair so peculiar: it meekly bends downward, and moves Madeleine's geometric shapes. Its thick leather covering brings out its elegance, and reaches its best in the version with armrests.

Именно сформованная спинка сиденья делает этот стул таким своеобразным: он безропотно наклоняется вниз и передвигает геометрические фигуры Madeleine. Его покрытие из плотной кожи подчеркивает элегантность и обретает лучшее в версии с подлокотниками.

## 7276

L 43 P 50 H 98/47

## 7268

L 46 P 50 H 98/47

## 7268B

L 65 P 50 H 98/47



**Madeleine 7276**  
Fully covered chair:  
thick leather (K\_60)



Madeleine 7268B  
Fully covered chair:  
burgundy red thick leather (K\_09)

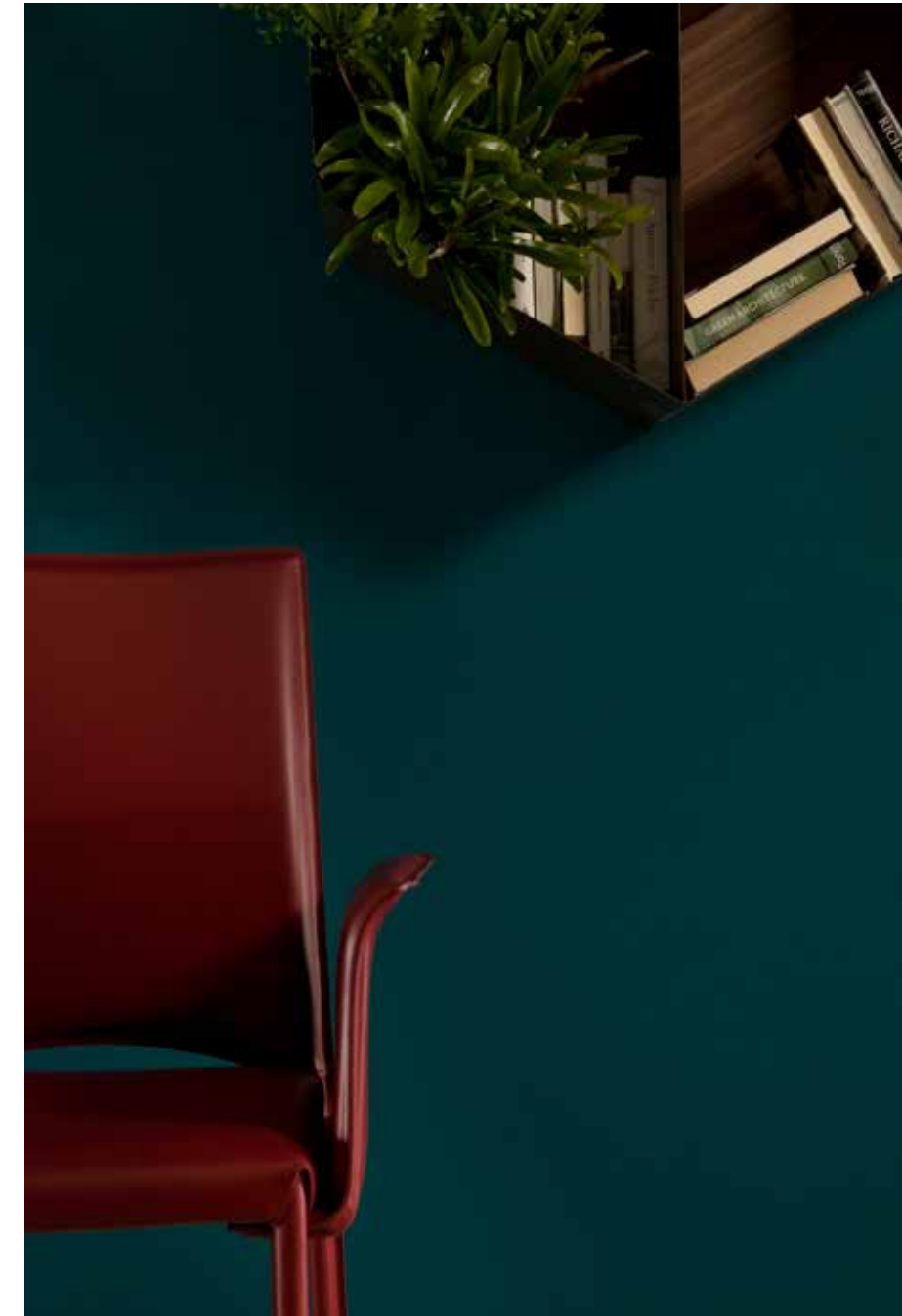

# mivida

design\_Angelo Tomaiuolo

Il poliuretano schiumato a freddo della struttura rende Mivida una sedia eccezionalmente comoda. Il design di Angelo Tomaiuolo è raffinato ed elegante, sia nella versione con braccioli, che in quella senza. Il rivestimento in pelle, eco-pelle, pelle fiore o pelle nabuk viene esaltato dalla raffinata cordatura.

Cold polyurethane foam was injected into this chair's structure, and that makes it exceptionally comfortable. Angelo Tomaiuolo's design is refined and elegant, both in the arm-free, and in the regular version. The leather, eco-leather, grain leather, or Nubuk leather upholstery are completed by the precious creasing.

Структура из холодного пенополиуретана делает стул Mivida исключительно удобным. Дизайн от Анджело Томайоло отличается изысканной элегантностью как модели с подлокотниками, так и без них. Обивка из кожи, искусственной кожи, кожи первой категории или нубука подчеркнута изысканной окантовкой шнуром.

**7212**

L 48 P 55 H 80/46

**7213**

L 65 P 58 H 80/46



**Mivida 7212 - 7213**

Ash wood structure, painted Canaletto walnut (14);  
chairs covered in: dark brown eco-leather (S\_70),  
white leather (P\_01), amber grain leather (PF\_68).  
Dark brown creasing (S\_70)



**Mivida 7213**  
Ash wood structure: painted Canaletto walnut (14); lavender leather covering (P\_52).  
Dark brown creasing (S\_70)



**Mivida 7212**  
Ash wood structure: painted natural oak (17);  
cream Nubuck eco-leather covering (SN\_01).  
White creasing (S\_01)

Frontale, in tutta la sua eleganza, Mivida è ricca di dettagli, di cuciture precise e di una cordonatura possibile solo grazie ad eccellenti doti sartoriali. Poggiata su di un materiale innovativo quanto la sua linea, si accomoda gentilmente negli ambienti più raffinati.

Look at it from the front: Mivida was enriched with details, and precise sewing; its creasing was only possible because of the excellent tailoring skills our artisans have mastered. An innovative material, and an innovative figure: Mivida can be set in the most refined spaces.

Стул Mivida, особенно, если рассматривать его с фронтальной стороны, не может не заставить восхищаться своей элегантностью: он богат деталями, точностью швов и окантовкой великолепного мастерского выполнения. Основание этой модели такое же инновационное, как сами линии кресла, достойного самого изысканного интерьера.



# navarra

design\_Studio Tonin Creatives

Semplice, morbida ed elegante, Navarra si riveste di pelle o eco-pelle, accostandosi lieve alle sale cui viene destinata.

Simple, soft and elegant, Navarra is covered in leather, or eco-leather; it perfectly matches the rooms it is destined to.

Простой, мягкий и элегантный Navarra покрыт кожей или эко-кожей; он прекрасно подходит к помещениям, для которых он предназначен.

**7266**

L 46 P 57 H 90/46

**Navarra 7266**  
Fully covered chair:  
ash grey eco-leather (S\_27)



# plaza

design\_Studio Tonin Creatives

Sedia con rivestimento in cuoio, o cuoio naturale nuvolato. Le cuciture possono essere scelte in tinta con il rivestimento, o con bordo a contrasto, per un effetto di maggior movimento ed elasticità.

This chair is covered in thick leather, or in naturally clouded thick leather. Two different kinds of stitching are available: same colour, or contrast colour. The latter allows to increase its movement and elasticity.

Этот стул покрыт плотной кожей или плотной кожей с естественными прожилками. Доступны два разных вида строчки: того же цвета или контрастного цвета. Последнее позволяет усилить его движение и эластичность.

7299

L 43 P 50 H 95/47



Plaza 7299  
Fully covered chair:  
white thick leather (K\_01)



# portofino

design\_Studio Archirivolto

Costruita con una struttura in legno, Portofino è una sedia la cui linea slanciata viene controbilanciata dal rivestimento a linee orizzontali dello schienale, e dalla morbida curvatura delle gambe. I rivestimenti in pelle, eco-pelle, pelle fiore e pelle nabuk, disponibili in varie colorazioni, la rendono facilmente abbinabile a tavoli di diversa fattura.

Portofino was built with a wooden structure: it is a quite willowy chair, yet its figure is balanced, thanks to the horizontal stripes that cover its back, and to the smoothly curved legs. The leather, eco-leather, grain leather and Nubuk leather upholsteries, available in different colors, make it extremely easy to coordinate with various kinds of tables.

Изящные линии стула Portofino с несущей основой из дерева дополняются обивкой с горизонтальными полосами на спинке и мягкостью округлых форм ножек. Обивка из кожи, искусственной кожи, кожи первой категории или нубука позволяет без проблем сочетать этот стул со столами самого разного типа и материала.

7218

L 43 P 57 H 95/47



**Portofino 7218**  
ashwood structure, painted dark oak (I6);  
covering: Burgundy red leather (P\_09)



# regina

design\_Studio Archirivolto

Sedia in poliuretano schiumato, materiale eccellente per la creazione di forme particolari, e di sedute estremamente confortevoli. I rivestimenti di Regina, che variano dalla pelle, all'eco-pelle, ai tessuti, arricchiscono ulteriormente la sua bellezza.

Foamed polyurethane was used to build this chair: this material is perfect to create various shapes, and to make every chair extremely comfortable. Regina's covering goes from leather, to eco-leather and fabrics, and enriches its simple beauty.

Для создания этого стула был использован пенополиуретан: этот материал идеально подходит для создания различных форм и наделяет каждого стула комфортностью. Покрытие Regina может быть выполнено из кожи и эко-кожи для украшения его простой красоты.

7201

L 47 P 53 H 81/46



Regina 7201  
Fully covered chair:  
dark brown nabuk eco-leather (SN\_05)

# scarlet

design\_Studio Tonin Creatives

Una seduta elegante e semplice, che si arricchisce di un raffinato cuscinetto imbottito. La comodità si unisce all'eleganza, nelle finiture in pelle, o eco-pelle.

Scarlet is simple and elegant, with a touch of preciousness given by its upholstered seat. Comfort marries elegance, and lives within the leather, or eco-leather finishes.

Scarlet — простой и элегантный, с оттенком роскоши, обеспечиваемой её мягким сиденьем. Комфорт объединяется с элегантностью и заключается в отделке кожей или эко-кожей.

7253

L 46 P 57 H 90/46



Scarlet 7253  
Fully covered chair:  
beige eco-leather (S\_36)





Scarlet 7253  
Fully covered chair:  
grey nabuk eco-leather (SN\_06)

# simply

design\_Angelo Tomaiuolo

Seduta con struttura tubulare in metallo cromato, che si arricchisce di una seduta in cuoio dal taglio moderno e professionale. Le cuciture e i bordi in tinta, o a contrasto, permettono di giocare con effetti di maggiore o minore dinamicità.

A tubular, chromed metal structure, enriches the thick leather seat, adding modernity to its professional looks. The same color, or contrast color stitching, allow to play with its dynamism.

Трубчатая, хромированная металлическая конструкция украшает сиденья из плотной кожи, добавляя штрих современности их профессиональному внешнему виду. Строчка того же цвета или контрастного цвета позволяет играть с его динамизмом.

7206

L 54 P 53 H 78/48



Simply 7206  
Chromed metal structure (72);  
naturally clouded thick leather (KN\_32)

# sorbona

design\_Studio 28

Le pelli ed eco-pelli più raffinate, rivestono il quieto lusso di Sorbona. Una sedia di Tonin Casa, pensata per arricchire, decorare e far risplendere il vostro living. Il lusso non è mai stato così dolce.

The most refined leather, or eco-leather, cover Sorbona's quiet luxury. A chair by Tonin casa, thought to enrichen, to decorate, to make your living room shine bright. Luxury never was this sweet.

Самая изысканная кожа или эко-кожа покрывает тихую роскошь Sorbona. Стул от Tonin Casa предназначен для украшения, декорирования, чтобы сделать вашу гостиную яркой. Роскошь никогда не была такой очаровательной.

7295

L 45 P 52 H 108/48



Sorbona 7295  
Fully covered chairs:  
mud eco-leather (S\_51),  
dove grey eco-leather (S\_60)

# sorrento

design\_Angelo Tomaiuolo

Sorrento nasce per accontentare due diverse preferenze: è una sedia con braccioli, per chi la desidera maggiormente strutturata; sia una sedia senza braccioli, aperta e leggera. La struttura è in frassino tinto rovere o noce, e può essere rivestita di pelle, eco-pelle, pelle fiore o pelle nabuk. La cordonatura raffinata può essere personalizzata con diverse colorazioni.

Sorrento was made to satisfy two different styles: it can be made with armrests, that enhance its structure, or without them, to obtain an open, lighter figure. The structure is made of ash wood finished oak, or walnut, and can be covered in leather, eco-leather, grain leather, or Nubuk leather. The refined creasing can be customized with different colors.

Стул Sorrento способен удовлетворить самые разные предпочтения: модель с подлокотниками для тех, кто ищет более структурированное решение, и классическая модель, открытая и легкая. Несущая конструкция из ясеня с отделкой под дуб или орех. Обивка из кожи, искусственной кожи, кожи первой категории или нубука. Тонкая отделка шнуром может быть персонализирована благодаря выбору цвета.

## 8043

L 50 P 65 H 96/47

## 8043B

L 63 P 65 H 96/47



### Sorrento 8043 - 8043B

Ash wood structure: painted dark oak (16) and Canaletto walnut (14).  
Covering: pink grain leather (PF\_06) with dark brown creasing (S\_70),  
dark brown eco-leather (S\_70) with dove grey creasing (S\_60)

Sorrento 8043  
Ash wood structure: painted  
Canaletto walnut (14);  
covering: light brown leather (P\_60)  
with dark brown creasing (S\_70)





Le cuciture esperte e le linee che tendono all'esterno, per dare completezza ed apertura ad un tempo. La qualità dell'alta sartoria si combina ad una struttura dal design marcato, mentre la seduta si poggia dolcemente sul proprio sostegno.

The expert sewing, the lines leaning out towards the outside, to complete and open at the same time. Haute couture quality combined with a pronounced design, a seat that softly leans on its base.

Умело выполненные швы и стремящиеся наружу линии обеспечивают одновременную открытость и полноту форм. Качество элитной обивки прекрасно сочетается с ярким дизайном структуры, где сиденье плавно ложится на несущую структуру.



# vivienne

design\_Studio 28

Sedia in poliuretano schiumato, con rivestimento in pelle, eco-pelle, tessuto verbena, tessuto ninfea. Una grande varietà di finiture che si abbinano eccellentemente con lo schienale dalle forme particolari e femminili. Un contemporaneo incanto d'altri tempi.

Foamed polyurethane seat; leather, eco-leather, Verbena fabric, or Ninfea fabric covering. A huge variety of finishes that perfectly match the peculiarly feminine backrest. A contemporary charm, from another time.

Сиденье из пенополиуретана; кожа, эко-кожа, ткань Verbena или покрытие тканью Ninfea. Огромное разнообразие отделки, которые отлично сочетаются со своеобразной женственной спинкой сиденья. Современный шарм из другого времени.

7258

L 50 P 65 H 96/47



Vivienne 7258  
Chromed metal structure (72);  
pink grain leather covering (PF\_06)





**Vivienne 7258**  
Chromed metal structure (72);  
brick red grain leather covering (PF\_65)





# milano

design\_Studio 28

Come la città cui si ispira, Milano è lineare, preciso e moderno: la base in metallo cromato si alza e conclude nella seduta curvilinea, rivestita in cuoio, o cuoio naturale nuvolato.

Just like the city it takes its inspiration from, Milano is linear, precise and modern: the chromed metal base lifts up and closes in a round-shaped seat, with thick leather, or naturally clouded thick leather coverings.

Так же, как и город, от которого он почерпнул свое вдохновение, Milano — вытянутый, аккуратный и современный: хромированное металлическое основание поднимается вверх и закрывается в сиденье круглой формы с плотной кожей или с покрытиями из плотной кожи с естественными прожилками.

6317

L 37 P 40 H 80/93



Milano 6317  
Chromed metal structure (72).  
Seats: White thick leather (K\_01);  
black thick leather (K\_73)



# mivida

design\_Angelo Tomaiuolo

Mivida diventa uno splendido ed elegante sgabello, con base in legno tinto noce, rovere scuro, o rovere naturale, e una seduta rivestita in pelle ed ecopelle. L'eleganza di Mivida aumenta ulteriormente, grazie alla forma leggera e slanciata della struttura.

Mivida becomes a marvelous and elegant stool, with a walnut, dark oak, or natural oak base, and a leather, or eco-leather covered seat. Mivida's elegance grows even more, thanks its light and slender structure.

Mivida — изумительный и элегантный стул с основанием из грецкого ореха, темного дуба или натурального дуба, а также с сиденьем, покрытым кожей или эко-кожей. Элегантность Mivida увеличивается еще больше благодаря его легкой и стройной конструкции.

6318

L 46 P 50 H 107/72  
(H1) L 46 P 50 H 99/64



Mivida 6318

Stool:

ash wood structure, painted natural oak (17);  
covering: cream Nubuck leather (PN\_05)  
with white creasing (S\_01)

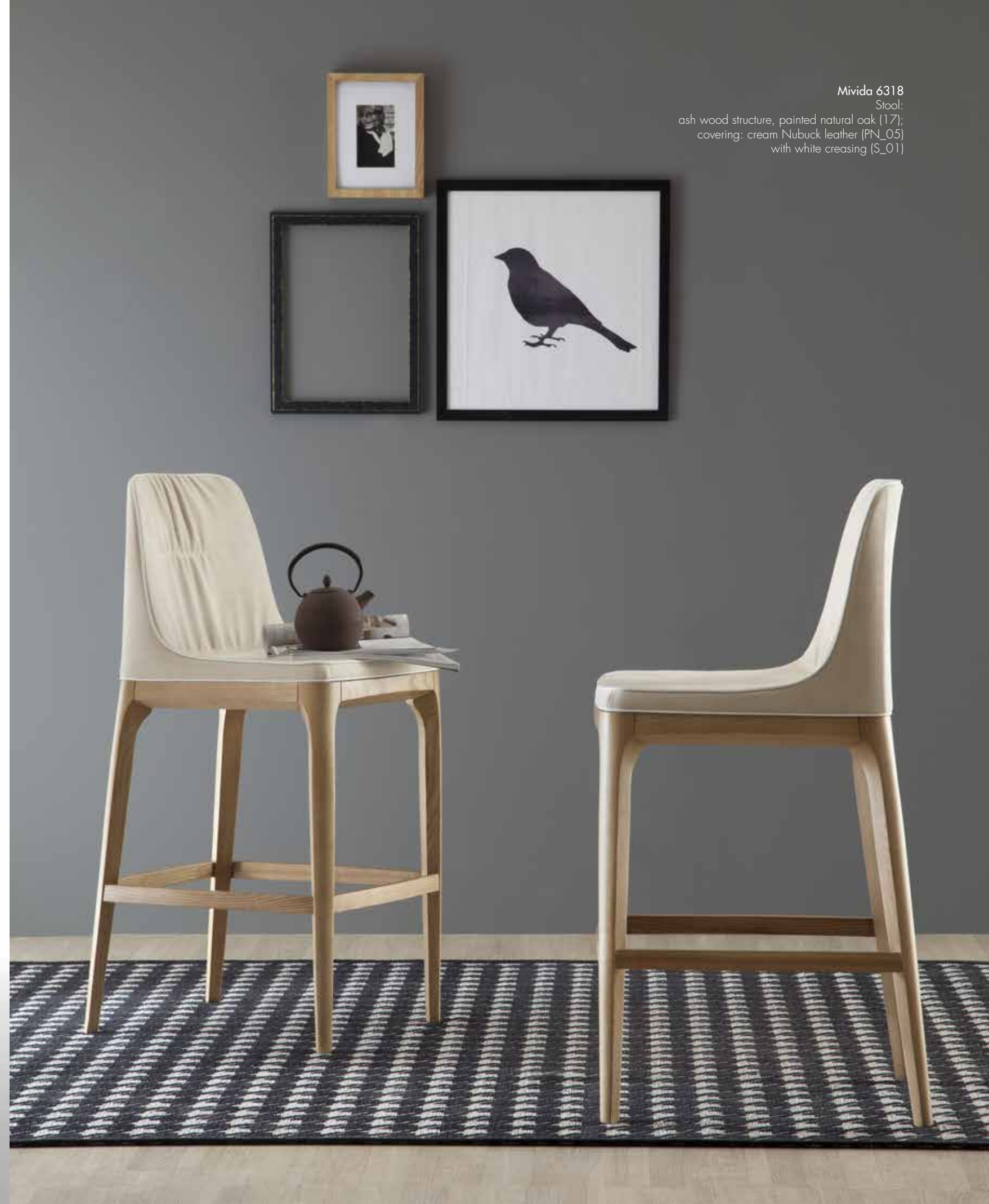

# oslo

design\_Studio 28

Sgabello girevole con base in metallo cromato, e una seduta in free-form tech, che ne fa un perfetto compagno per mobili alti, isole e sezioni bar.

This is a swivelling stool, with a chromed metal base, and a free-form tech seat that makes it the perfect companion for your high furniture, you counter-tops, and your bars.

Этот вращающийся стул с хромированным металлическим основанием и технологичным сиденьем свободной формы является идеальным компаньоном для вашей высокой мебели, столешниц и барных стоек.

**6319**

L 45 P 53 H 60-80/85-105



**Oslo 6319**  
Chromed metal structure (72).  
Seats: white (01);  
black (02)







# duny

design\_Angelo Tomaiuolo

Un divano che avvolge come un guanto, in tutte le finiture in pelle ed ecopelle, capaci di risaltarne forma e curvatura. Un esempio di morbida innovazione, per ogni living.

This sofa will embrace you like a glove; its every finishing - both leather and eco-leather - exholt its peculiar shape and curves. An example of soft innovation, perfect for every living-room.

Этот диван окутает вас, как перчатка; любой вариант его отделки — кожа или эко-кожа — подчеркивает его особенную форму и изгибы. Это — пример мягких инноваций, который идеально подойдет для любой гостиной.

7380

L 237 P 100 H 40/46



Duny 7380  
Sofa:  
covered in beige  
eco-leather (S\_36)





Duny 7380  
Sofa:  
covered in white leather (P\_01)

# nolita

design\_Studio 28

Tutto il comfort della modernità di Nolita, si esprime attraverso il suo design: braccioli ben segnati e una seduta ampia e dal taglio innovativo, per creare una poltrona girevole di estrema utilità e bellezza.

Nolita's comfort is best expressed by its design: perfectly drawn armrests, and a wide and innovatively shaped seat, made to create an extremely useful and beautiful swivelling armchair.

Комфорт NOLITA лучше всего выражается в его конструкции: отлично нарисованные подлокотники, а также широкое сиденье инновационной формы, созданное для того, чтобы создать чрезвычайно практичное и красивое поворотное кресло.

**AT111R**

L 70 P 85 H 42/118



**Nolita AT111R**  
Armchair:  
covered in mud eco-leather (S\_51)

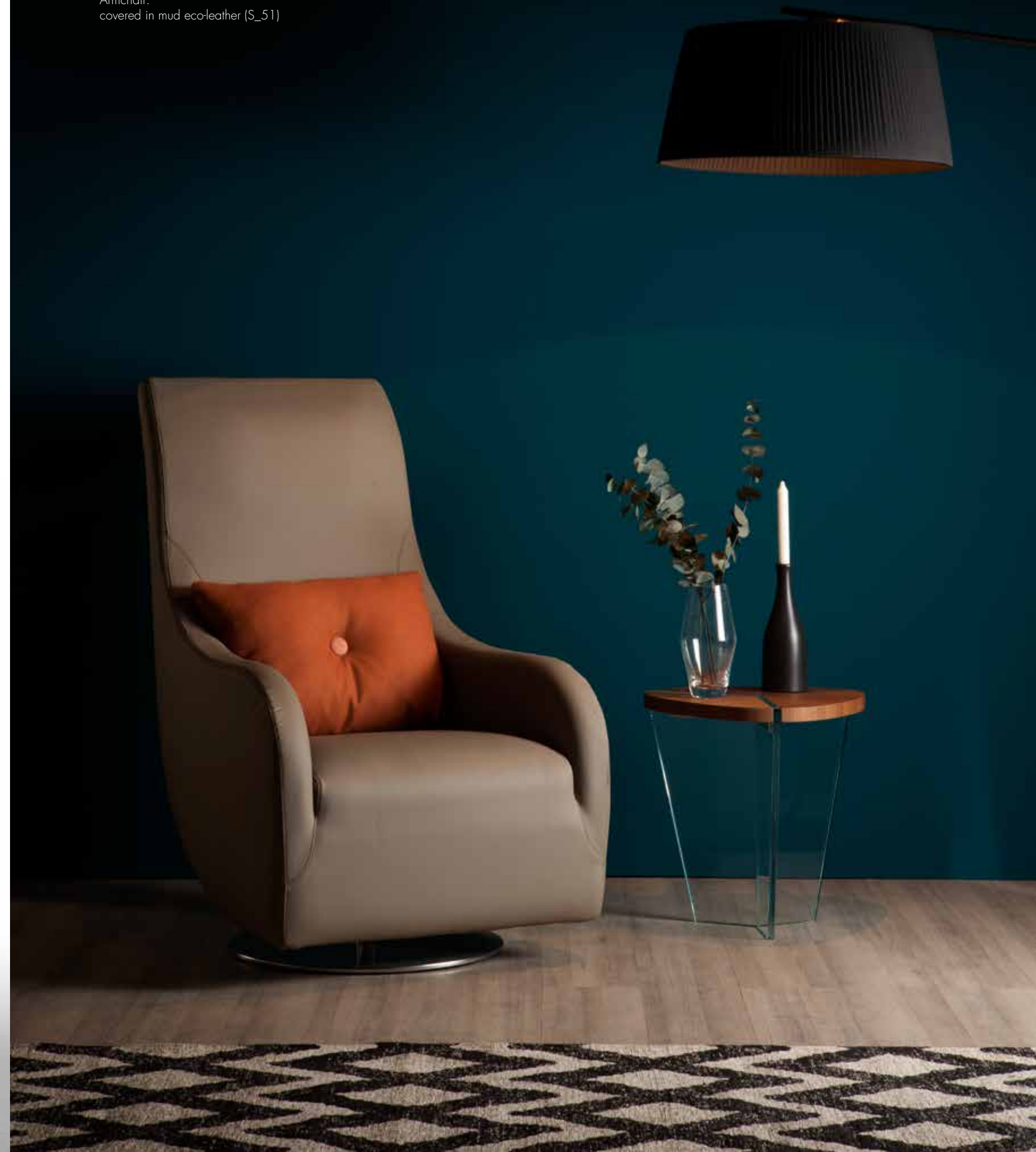

# ricciolo

design\_Angelo Tomaiuolo

Ricciolo è una poltrona, una chaise-longue, un articolo per rendere qualunque stanza unica. Dotata di un meccanismo pieghevole brevettato, è disponibile in diversi rivestimenti, quali pelle, eco-pelle, pelle fiore, tessuto elastico orchidea e velluto.

Ricciolo is an armchair, a chaise-longue, a product that can make every room unique. The patented folding mechanism is what makes this curly seat a must. Different upholsteries are available, such as leather, eco-leather, grain leather, Orchidea elastic fabric and velvet.

Ricciolo включает в себе характеристики кресла и шезлонга. Эта модель способна сделать уникальной любую комнату. Кресло с запатентованным складным механизмом с обивкой по выбору заказчика: кожа, искусственная кожа, кожа первой категории или эластичная ткань "орхидея" и бархат.

7865

L 65 P 95/145 H 90



Ricciolo 7865  
Seats/Chaiselongues:  
covered in mud Orchidea fabric (TO\_51),  
white eco-leather (S\_01)



Ricciolo 7865  
Seat/Chaiselongue:  
covered in white eco-leather (S\_01)





Riccio 7865  
Seat/Chaiselongue:  
covered in old burgundy red (T\_06V)

Un ricciolo per modificare lo spazio, per passare da una seduta fluida, distesa, che si allunghi nella stanza, ad una poltrona solida ed elegante. Un'onda morbida e compatta, esempio di innovazione ed accurata attenzione per i dettagli: il design di Tonin Casa.

A curl to alter spaces, to start as a fluid, relaxed chaise, and become an elegant and solid armchair. A soft and compact wave, an example of innovation and care for details: Tonin Casa's design.

Завиток (он названия кресла) изменяет восприятие пространства, превращая удлиненный шезлонг в собранное и элегантное кресло. Ощущение мягкой и компактной волны, пример передового дизайна и внимания к деталям от мебельного дома Tonin Casa.



# tiffany

design\_Angelo Tomaiuolo

Una poltrona o un divano che si ispira ad un lusso morbido e delicato: il legno di frassino, in finitura noce Canaletto, rovere scuro, o rovere naturale, si abbina lieve al rivestimento in pelle ed eco-pelle, in tutte le colorazioni disponibili. Trapuntata e rivestita con la migliore qualità Made in Italy, Tiffany riesce a combinare materiali e linee complesse, unendoli in un prodotto dalla grazia unica.

Tiffany is an armchair, or a sofa, inspired by a soft and delicate luxury: the ash tree - with a Canaletto walnut, dark oak, or natural oak finishing - quietly marries the leather, or eco-leather covering. A quilted covering, representation of the best Made in Italy manufacture, covers Tiffany, and combines two technically different worlds, resulting in a uniquely gracious product.

Tiffany — это кресло или диван, вдохновленные мягкой и нежной роскошью: ясень — с грецким орехом Каналетто, темным дубом или натуральной отделкой дуба — создает мягкое сочетание с покрытием из кожи или эко-кожи. Стеганое покрытие — пример лучшего производства «Сделано в Италии» — украшает Tiffany и сочетает в себе два технически разных мира, создавая уникально милый продукт.

## 7333

L 100 P 82 H 80

## 7334

L 190 P 82 H 80



## Tiffany 7333

Armchair:

ashwood structure, painted Canaletto walnut (14);  
covering: amber grain leather (PF\_08) with rhombus pattern







Tiffany 7333  
Armchair:  
ashwood structure, painted dark oak (16);  
covering: Burgundy red leather (P\_09) with rhombus pattern

**Tiffany 7333 - 7334**  
Ash wood stucture, painted Canaletto walnut (14);  
covering: dark brown eco-leather (S\_70) with  
rhombus pattern



Tiffany 7334

Sofa:  
ashwood structure, painted dark oak (16);  
covering: nabuck leather ecru (PN\_100)  
with rhombus pattern



specifiche  
specifications

**8002FSV** fixed - tempered glass top - shaped top 

(A) L 200 P 100 H 75 cm (sp. 12 mm)  
(G) L 250 P 120 H 75 cm (sp. 12 mm)

**8002FSL** fixed - wooden top - shaped top 

(A) L 200 P 100 H 75 cm (sp. 20 mm)  
(G) L 250 P 120 H 75 cm (sp. 20 mm)  
(Z) L 300 P 120 H 75 cm (sp. 20 mm)

**8002FSM** fixed - marble top - shaped top 

(A) L 200 P 100 H 75 cm (sp. 20 mm)  
(G) L 250 P 120 H 75 cm (sp. 20 mm)

**8002FSC** fixed - porcelain stoneware top - shaped top 

(A) L 200 P 100 H 75 cm (sp. 16 mm)  
(G) L 250 P 120 H 75 cm (sp. 16 mm)  
(Z) L 300 P 120 H 75 cm (sp. 16 mm)

**8002** extendible - glass / ceramic glass top / porcelain stoneware 

(P) L 160/240 P 90 H 75  
(A) L 180/260 P 90 H 75  
(G) L 200/300 P 100 H 75  
(D) L 200/300 P 110 H 75

**8002FSV - 8002FSM**

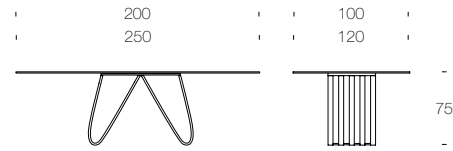

**8002FSL - 8002FSC**

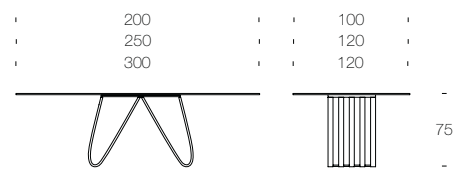

**8002**

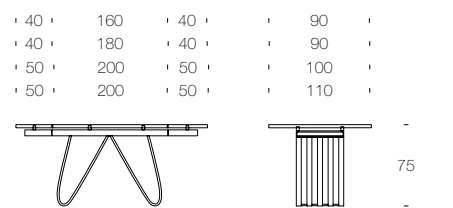

**8057FSV** fixed - tempered glass top - shaped top 

(LP) L 133 P 133 H 75 cm (sp. 12 mm)  
(LA) L 200 P 100 H 75 cm (sp. 12 mm)  
(LG) L 250 P 120 H 75 cm (sp. 12 mm)  
(LZ) L 300 P 120 H 75 cm (sp. 12 mm)

**8057FSL** fixed - wooden top - shaped top 

(LP) L 133 P 133 H 75 cm (sp. 20 mm)  
(LA) L 200 P 100 H 75 cm (sp. 20 mm)  
(LG) L 250 P 120 H 75 cm (sp. 20 mm)  
(LZ) L 300 P 120 H 75 cm (sp. 20 mm)

**8057FLM** fixed - solid wood top 

(A) L 200 P 106 H 75 cm (sp. 40 mm)  
(G) L 250 P 106 H 75 cm (sp. 40 mm)  
(Z) L 300 P 120 H 75 cm (sp. 40 mm)

**8057FSC** fixed - porcelain stoneware top - shaped top 

(LP) L 133 P 133 H 75 cm  
(LA) L 200 P 100 H 75 cm  
(LG) L 250 P 120 H 75 cm  
(LZ) L 300 P 120 H 75 cm

**8057FSV - 8057FSL - 8057FSC**

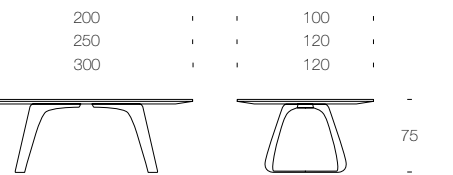

**8057FLM**

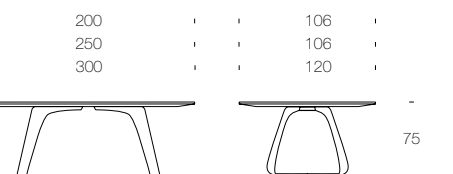

specifiche - specifications

per il campionario completo vedi le pagine finali  
for the complete samples see the final pages

**8000FSV** fixed - tempered glass top 

(FP) L 160 P 90 H 75 cm (sp. 12 mm)  
(FA) L 180 P 90 H 75 cm (sp. 12 mm)  
(FG) L 200 P 100 H 75 cm (sp. 12 mm)

**8000FSC** fixed - ceramic glass / porcelain stoneware top 

(FP) L 160 P 90 H 75 cm  
(FA) L 180 P 90 H 75 cm  
(FG) L 200 P 100 H 75 cm

**8000** extendible - glass / ceramic glass / porcelain stoneware top 

(P) L 160/240 P 90 H 75  
(A) L 180/260 P 90 H 75  
(G) L 200/300 P 100 H 75

**8000FSV - 8000FSC**

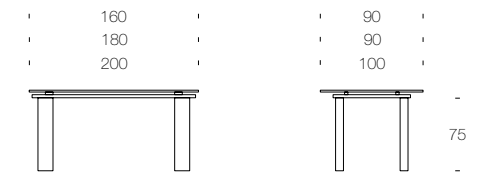

**8000**

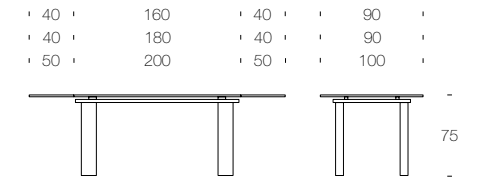

**8070FSV** fixed - tempered glass top - round /shaped top 

(T) Ø 160 H 75 cm (sp. 12 mm)  
(P) L 133 P 133 H 75 cm (sp. 12 mm)  
(A) L 200 P 106 H 75 cm (sp. 12 mm)  
(G) L 250 P 106 H 75 cm (sp. 12 mm)  
(Z) L 300 P 120 H 75 cm (sp. 12 mm)

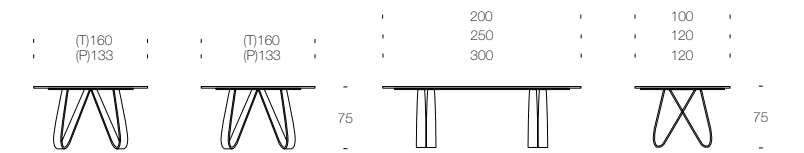

**8070FSL** fixed - wooden top - shaped top 

(LP) L 133 P 133 H 75 cm (sp. 20 mm)  
(LA) L 200 P 100 H 75 cm (sp. 20 mm)  
(LG) L 250 P 120 H 75 cm (sp. 20 mm)  
(LZ) L 300 P 120 H 75 cm (sp. 20 mm)

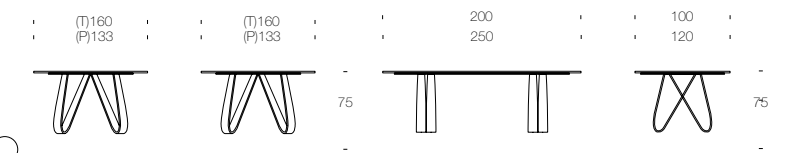

**8070FSM** fixed - marble top - round /shaped top 

(T) Ø 160 H 75 cm (sp. 20 mm)  
(P) L 133 P 133 H 75 cm (sp. 20 mm)  
(A) L 200 P 106 H 75 cm (sp. 20 mm)  
(G) L 250 P 106 H 75 cm (sp. 20 mm)

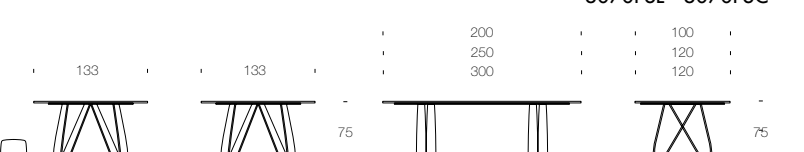

**8070FSC** fixed - porcelain stoneware top - shaped top 

(P) L 133 P 133 H 75 cm  
(A) L 200 P 106 H 75 cm  
(G) L 250 P 106 H 75 cm  
(Z) L 300 P 120 H 75 cm

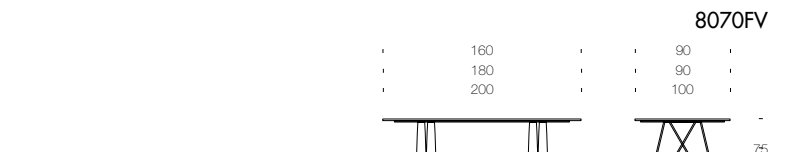

**8070FV** fixed - tempered glass top 

(FP) L 160 P 90 H 75 cm (sp. 12 mm)  
(FA) L 180 P 90 H 75 cm (sp. 12 mm)  
(FG) L 200 P 100 H 75 cm (sp. 12 mm)



**8070** extendible - tempered glass top 

(P) L 160/240 P 90 H 75  
(A) L 180/260 P 90 H 75  
(G) L 200/300 P 100 H 75

specifiche - specifications

per il campionario completo vedi le pagine finali  
for the complete samples see the final pages

**8069FSV** fixed - tempered glass top  

(T) Ø 140 H 75 cm  
(P) Ø 160 H 75 cm  
(A) Ø 180 H 75 cm  
(E) L 220 P 120 H 75 cm

**8069FSV**

Ø 140  
Ø 160  
Ø 180



**8069FSL**

Ø 140  
Ø 160

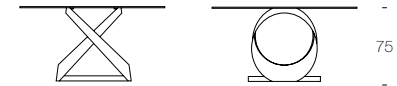

**8069FSL** fixed - wooden top  

(T) Ø 140 H 75 cm  
(P) Ø 160 H 75 cm  
(E) L 220 P 120 H 75 cm

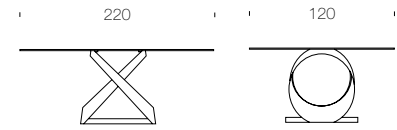
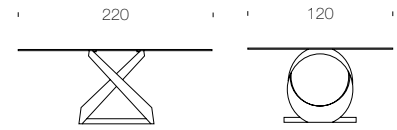

colosseo - big colosseo

**8076FSV** fixed - tempered glass top  

(T) Ø 140 H 75 cm  
(P) Ø 160 H 75 cm  
(A) Ø 180 H 75 cm  
(E) L 220 P 120 H 75 cm

**8076FSV**

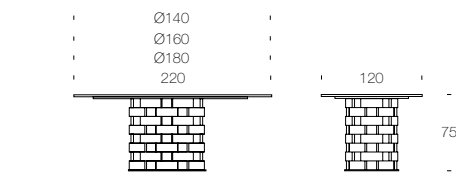

**8076FSM** fixed - marble top  

(T) Ø 160 H 75 cm (sp. 20 mm)  
(P) L 200 P 100 H 75 cm (sp. 20 mm)  
(A) L 250 P 100 H 75 cm (sp. 20 mm)

**8076FSM**

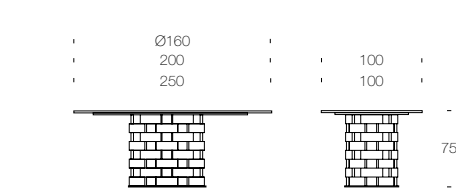

**8076FSC** fixed - porcelain stoneware top   

(T) Ø 140 H 75 cm (sp. 16 mm)  
(E) L 220 P 120 H 75 cm (sp. 16 mm)  
(P) L 200 P 100 H 75 cm (sp. 16 mm)  
(A) L 250 P 100 H 75 cm (sp. 16 mm)

**8076**

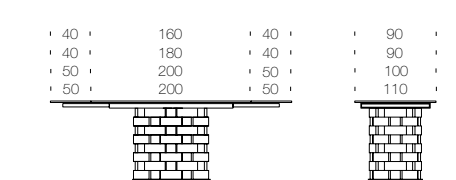

**8076** extendible - tempered glass top  

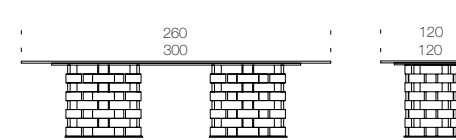

(P) L 160/240 P 90 H 75 (sp. 12 mm)  
(A) L 180/260 P 90 H 75 (sp. 12 mm)  
(G) L 200/300 P 100 H 75 (sp. 12 mm)  
(D) L 200/300 P 110 H 75 (sp. 12 mm)

**8077**



**8076** extendible - ceramic glass top  

(P) L 160/240 P 90 H 75  
(A) L 180/260 P 90 H 75  
(G) L 200/300 P 100 H 75

**8077FV** fixed - tempered glass / porcelain stoneware top  

(OK) L 260 P 120 H 75 (sp. 12 mm)  
(OX) L 300 P 120 H 75 (sp. 12 mm)  
(RZ) L 240 P 120 H 75 (sp. 12 mm)  
(RK) L 300 P 120 H 75 (sp. 12 mm)

specifiche - specifications

per il campionario completo vedi le pagine finali  
for the complete samples see the final pages



**8075** extendible - wooden top 

(P) L 140/188 P 90 H 75 cm  
(A) L 160/208 P 90 H 75 cm

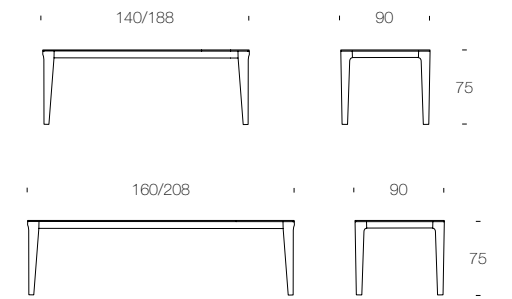
**8075**



eliseo - big eliseo

**8028FSV** fixed - tempered glass top  

(TP) Ø 120 H 75 cm (sp. 12 mm)  
(T) Ø 140 H 75 cm (sp. 12 mm)  
(E) L 200 P 105 H 75 cm (sp. 12 mm)

**8028FSV - 8028FSL - 8028FSC**

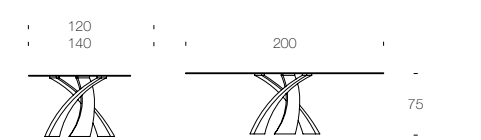



**8028FSL** fixed - wooden top  

(P) Ø 120 H 75 cm (sp. 40 mm)  
(A) Ø 140 H 75 cm (sp. 40 mm)  
(E) L 220 P 120 H 75 cm (sp. 40 mm)

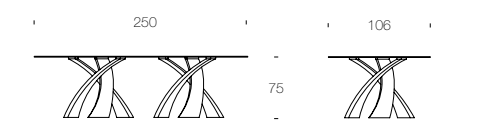
**8057FLM**



**8028FSC** fixed - porcelain stoneware top  

(TP) Ø 120 H 75 cm (sp. 16 mm)  
(T) Ø 140 H 75 cm (sp. 16 mm)  
(E) L 200 P 105 H 75 cm (sp. 16 mm)

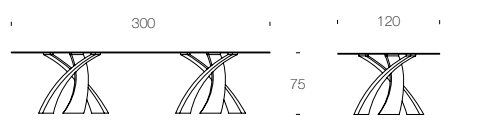

**8057FLM** fixed - solid wood top 

(G) L 250 P 106 H 75 cm (sp. 40 mm)  
(Z) L 300 P 120 H 75 cm (sp. 40 mm)

**8061FV**

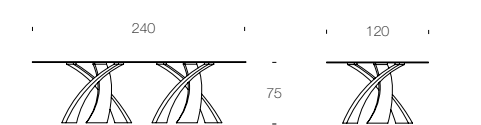

**8061FV** fixed - tempered glass / porcelain stoneware top  

(OK) L 260 P 120 H 75 (sp. 12 mm)  
(OX) L 300 P 120 H 75 (sp. 12 mm)  
(RZ) L 240 P 120 H 75 (sp. 12 mm)  
(RK) L 300 P 120 H 75 (sp. 12 mm)

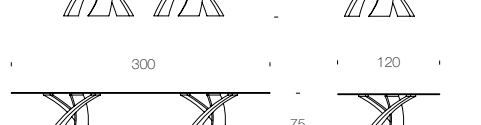
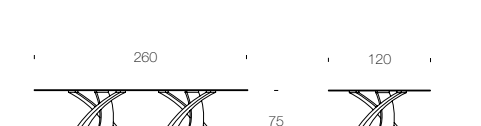
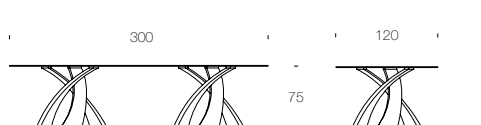

specifiche - specifications

per il campionario completo vedi le pagine finali  
for the complete samples see the final pages

**8067FSV** fixed - tempered glass / porcelain stoneware top ○

(P) Ø 120 H 75 cm  
(A) Ø 140 H 75 cm

**8078FV** fixed - tempered glass / porcelain stoneware top ○ □

(OK) L 260 P 120 H 75 (sp. 12 mm)  
(OX) L 300 P 120 H 75 (sp. 12 mm)  
(RZ) L 240 P 120 H 75 (sp. 12 mm)  
(RK) L 300 P 120 H 75 (sp. 12 mm)

**8067FSV**

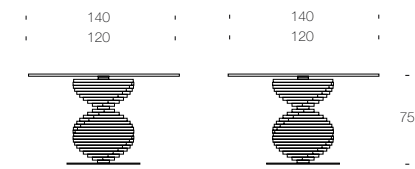

**8078FV**

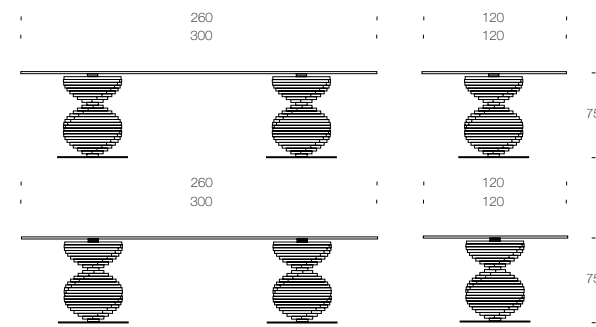

gaya - big gaya

**8071FSV** fixed - tempered glass top ○

(TP) Ø 120 H 75 cm (sp. 12 mm)  
(T) Ø 140 H 75 cm (sp. 12 mm)

**8071FSC** fixed - porcelain stoneware top ○

(TP) Ø 120 H 75 cm (sp. 16 mm)  
(T) Ø 140 H 75 cm (sp. 16 mm)

**8074FV** fixed - tempered glass top ○ □

(OK) L 260 P 120 H 75 (sp. 12 mm)  
(OX) L 300 P 120 H 75 (sp. 12 mm)  
(RZ) L 240 P 120 H 75 (sp. 12 mm)  
(RK) L 300 P 120 H 75 (sp. 12 mm)

**8074FV** fixed - porcelain stoneware top ○ □

(OK) L 260 P 120 H 75 (sp. 16 mm)  
(OX) L 300 P 120 H 75 (sp. 16 mm)  
(RZ) L 240 P 120 H 75 (sp. 16 mm)  
(RK) L 300 P 120 H 75 (sp. 16 mm)

**8071FSV - 8071FSC**

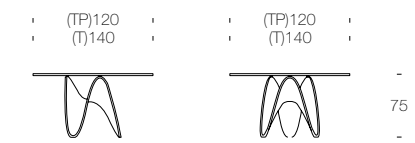

**8074FV**

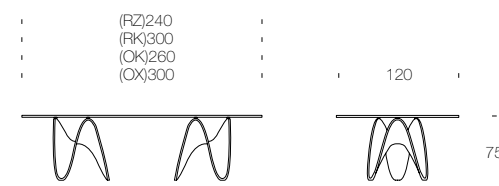

specifiche - specifications

per il campionario completo vedi le pagine finali  
for the complete samples see the final pages

**8010FSV** fixed - tempered glass top ○

(PEL) L 180 P 105 H 75 (sp. 12 mm)  
(EU) L 200 P 105 H 75 (sp. 12 mm)  
(L) L 220 P 120 H 75 (sp. 12 mm)

**8010FSC** fixed - porcelain stoneware top ○

(PEL) L 180 P 105 H 75 (sp. 16 mm)  
(EU) L 200 P 105 H 75 (sp. 16 mm)  
(L) L 220 P 120 H 75 (sp. 16 mm)

**8010FSV - 8010FSC**

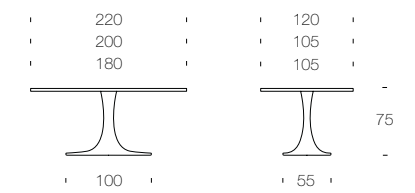

light

**8065FSV** extendible - tempered glass top □ □ □

(P) L 140/185 P 90 H 75 (sp. 12 mm)  
(A) L 160/205/250 P 90 H 75 (sp. 12 mm)  
(G) L 180/225/270 P 90 H 75 (sp. 12 mm)

**8065FSL** extendible - wooden top □ □ □

(P) L 140/185 P 90 H 75 (sp. 12 mm)  
(A) L 160/205/250 P 90 H 75 (sp. 12 mm)  
(G) L 180/225/270 P 90 H 75 (sp. 12 mm)

**8065FSC** extendible - ceramic glass top □ □ □

(P) L 140/185 P 90 H 75 (sp. 12 mm)  
(A) L 160/205/250 P 90 H 75 (sp. 12 mm)  
(G) L 180/225/270 P 90 H 75 (sp. 12 mm)

**8065FSV - 8065FSL - 8065FSC**

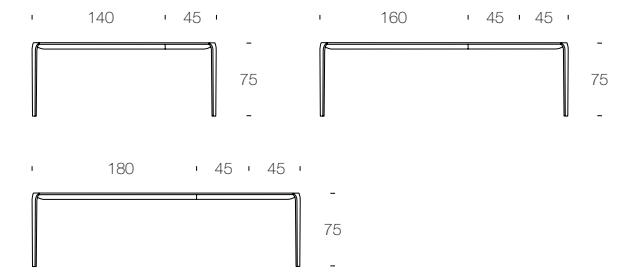

manhattan

**8051FSV** fixed - tempered glass top - shaped top □

(A) L 200 P 100 H 75 cm (sp. 12 mm)  
(G) L 250 P 120 H 75 cm (sp. 12 mm)  
(Z) L 300 P 120 H 75 cm (sp. 12 mm)

**8051FSL** fixed - wooden top - shaped top □

(A) L 200 P 100 H 75 cm (sp. 20 mm)  
(G) L 250 P 120 H 75 cm (sp. 20 mm)  
(Z) L 300 P 120 H 75 cm (sp. 20 mm)

**8051FLM** fixed - solid wood top □

(A) L 200 P 106 H 75 cm (sp. 40 mm)  
(G) L 250 P 106 H 75 cm (sp. 40 mm)  
(Z) L 300 P 120 H 75 cm (sp. 40 mm)

**8051FSM** fixed - marble top - shaped top □

(A) L 200 P 100 H 75 cm (sp. 20 mm)  
(G) L 250 P 120 H 75 cm (sp. 20 mm)

**8051FSV - 8051FSL - 8051FSM - 8051FSC**

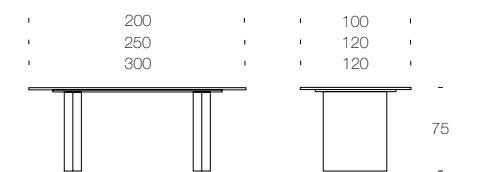

**8051FLM**

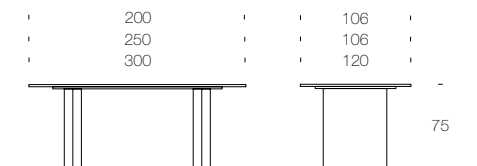

specifiche - specifications

per il campionario completo vedi le pagine finali  
for the complete samples see the final pages

**8051FSC** fixed - porcelain stoneware top - shaped top 

- (A) L 200 P 100 H 75 cm (sp. 12 mm)
- (G) L 250 P 120 H 75 cm (sp. 12 mm)
- (Z) L 300 P 120 H 75 cm (sp. 12 mm)

**8051** extendible - tempered glass top 

- (P) L 160/240 P 90 H 75 (sp. 12 mm)
- (A) L 180/260 P 90 H 75 (sp. 12 mm)
- (G) L 200/300 P 100 H 75 (sp. 12 mm)
- (D) L 200/300 P 110 H 75 (sp. 12 mm)

**8051** extendible - ceramic glass top / porcelain stoneware 

- (P) L 160/240 P 90 H 75 (sp. 12 mm)
- (A) L 180/260 P 90 H 75 (sp. 12 mm)
- (G) L 200/300 P 100 H 75 (sp. 12 mm)
- (D) L 200/300 P 110 H 75 (sp. 12 mm)

**8051**

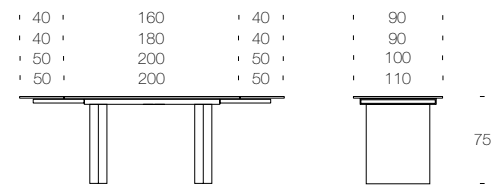

**6907FSV** fixed - tempered glass top 

- (T) Ø 140 H 75 cm
- (P) Ø 160 H 75 cm
- (E) L 220 P 120 H 75 cm

**6907FSV** fixed - porcelain stoneware top 

- (T) Ø 140 H 75 cm
- (E) L 220 P 120 H 75 cm

**6907FSV**



**8068** fixed - wooden top 

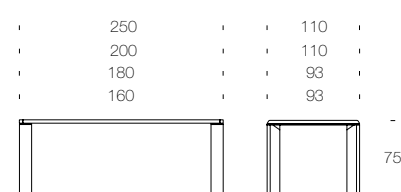

- (N) L 160 P 93 H 75 cm
- (S) L 180 P 93 H 75 cm
- (A) L 200 P 110 H 75 cm
- (G) L 250 P 110 H 75 cm

**8068**



specifiche - specifications

per il campionario completo vedi le pagine finali  
for the complete samples see the final pages

**6951FSV** fixed - tempered glass top - rectangular /shaped top  

- (FP) L 160 P 90 H 75 cm (sp. 12 mm)
- (FA) L 180 P 90 H 75 cm (sp. 12 mm)
- (FG) L 200 P 100 H 75 cm (sp. 12 mm)
- (A) L 200 P 100 H 75 cm (sp. 12 mm)
- (G) L 250 P 120 H 75 cm (sp. 12 mm)
- (Z) L 300 P 120 H 75 cm (sp. 12 mm)

**6951FSL** fixed - wooden top - shaped top 

- (A) L 200 P 100 H 75 cm (sp. 20 mm)
- (G) L 250 P 120 H 75 cm (sp. 20 mm)
- (Z) L 300 P 120 H 75 cm (sp. 20 mm)

**6951FL** fixed - marble top - rectangular top 

- (G) L 300 P 110 H 75 cm (sp. 40 mm)
- (A) L 250 P 110 H 75 cm (sp. 40 mm)
- (P) L 200 P 110 H 75 cm (sp. 40 mm)
- (S) L 180 P 93 H 75 cm (sp. 40 mm)
- (N) L 160 P 93 H 75 cm (sp. 40 mm)

**6951FLM** fixed - solid wood top 

- (A) L 200 P 106 H 75 cm (sp. 40 mm)
- (G) L 250 P 106 H 75 cm (sp. 40 mm)
- (Z) L 300 P 120 H 75 cm (sp. 40 mm)

**6951FSM** fixed - marble top - shaped top 

- (A) L 200 P 100 H 75 cm (sp. 20 mm)
- (G) L 250 P 120 H 75 cm (sp. 20 mm)

**6951FV** fixed - glass ceramic / porcelain stoneware top 

- (FP) L 160 P 90 H 75 cm (sp. 12 mm)
- (FA) L 180 P 90 H 75 cm (sp. 12 mm)
- (FG) L 200 P 100 H 75 cm (sp. 12 mm)

**6951FV** fixed - porcelain stoneware top 

- (A) L 200 P 100 H 75 cm (sp. 16 mm)
- (G) L 250 P 120 H 75 cm (sp. 16 mm)
- (Z) L 300 P 120 H 75 cm (sp. 16 mm)

**6951** extendible - tempered glass top 

- (P) L 160/240 P 90 H 75 (sp. 12 mm)
- (A) L 180/260 P 90 H 75 (sp. 12 mm)
- (G) L 200/300 P 100 H 75 (sp. 12 mm)

**6951** extendible - wooden top 

- (P) L 160/244 P 93 H 75 (sp. 40 mm)
- (A) L 180/264 P 93 H 75 (sp. 40 mm)
- (G) L 200/284 P 100 H 75 (sp. 40 mm)

**6951** extendible - ceramic glass / porcelain stoneware top 

- (P) L 160/240 P 90 H 75
- (A) L 180/260 P 90 H 75
- (G) L 200/300 P 100 H 75

**6951FSV - 6951FV**

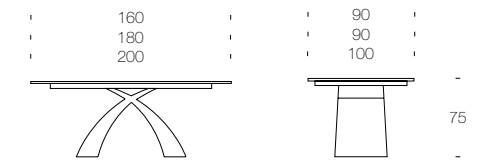

**6951FSV - 6951FSL - 6951FV**

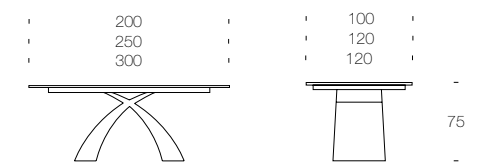

**6951FL**

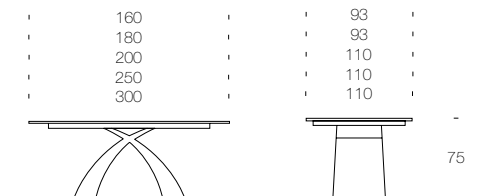

**6951FLM**

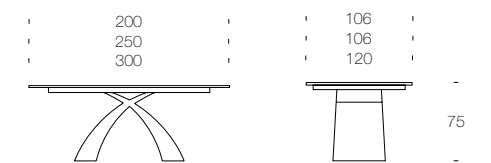

**6951FSM**

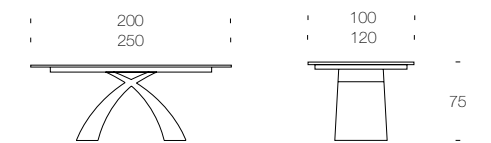

**6951**

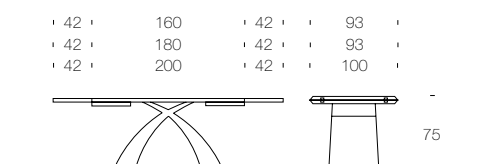
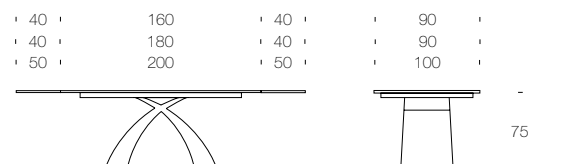

specifiche - specifications

per il campionario completo vedi le pagine finali  
for the complete samples see the final pages



**8011FV** fixed - tempered glass top 

(P) L 160 P 90 H 75 cm (sp. 12 mm)  
 (A) L 180 P 90 H 75 cm (sp. 12 mm)  
 (G) L 200 P 100 H 75 cm (sp. 12 mm)

**8011FL** fixed - wooden top 

(D) L 300 P 110 H 75 cm (sp. 40 mm)  
 (G) L 250 P 110 H 75 cm (sp. 40 mm)  
 (A) L 200 P 110 H 75 cm (sp. 40 mm)  
 (S) L 180 P 93 H 75 cm (sp. 40 mm)  
 (N) L 160 P 93 H 75 cm (sp. 40 mm)

**8011FV** fixed - ceramic glass / porcelain stoneware top 

(P) L 160 P 90 H 75 cm  
 (A) L 180 P 90 H 75 cm  
 (G) L 200 P 100 H 75 cm

**8011** extendible - tempered glass top 

(P) L 160/240 P 90 H 75 (sp. 12 mm)  
 (A) L 180/260 P 90 H 75 (sp. 12 mm)  
 (G) L 200/300 P 100 H 75 (sp. 12 mm)

**8011** extendible - wooden top 

(P) L 160/244 P 93 H 75 (sp. 40 mm)  
 (A) L 180/264 P 93 H 75 (sp. 40 mm)  
 (G) L 200/284 P 100 H 75 (sp. 40 mm)

**8011** extendible - ceramic glass / porcelain stoneware top 

(P) L 160/240 P 90 H 75  
 (A) L 180/260 P 90 H 75  
 (G) L 200/300 P 100 H 75

**8011FV**

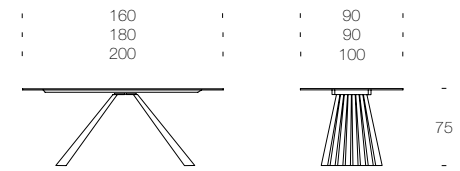

**8011FL**

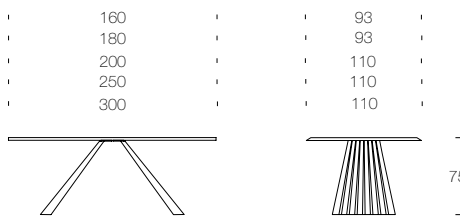

**8011**

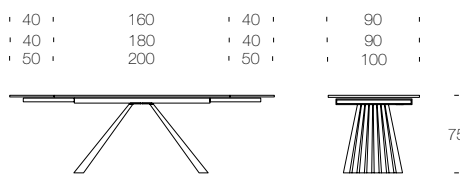

**8014FLM** fixed - solid wood top 

(A) L 200 P 106 H 75 cm (sp. 40 mm)  
 (G) L 250 P 106 H 75 cm (sp. 40 mm)  
 (Z) L 300 P 120 H 75 cm (sp. 40 mm)

**8014FSM** fixed - marble top - shaped top 

(FP) L 200 P 100 H 75 cm (sp. 20 mm)  
 (FA) L 250 P 120 H 75 cm (sp. 20 mm)

**8014FRC** fixed - ceramic glass / porcelain stoneware top 

(FP) L 160 P 90 H 75 cm  
 (FA) L 180 P 90 H 75 cm  
 (FG) L 200 P 100 H 75 cm  
 (FD) L 200 P 110 H 75 cm

**8014FSC** fixed - porcelain stoneware top  

(FP) L 200 P 100 H 75 cm (sp. 16 mm)  
 (FA) L 200 P 120 H 75 cm (sp. 16 mm)  
 (FD) L 300 P 120 H 75 cm (sp. 16 mm)  
 (EL) L 200 P 105 H 75 cm (sp. 16 mm)  
 (ER) L 220 P 110 H 75 cm (sp. 16 mm)

**8014** extendible - tempered glass top 

(P) L 160/240 P 90 H 75 (sp. 12 mm)  
 (A) L 180/260 P 90 H 75 (sp. 12 mm)  
 (G) L 200/300 P 100 H 75 (sp. 12 mm)  
 (D) L 200/300 P 110 H 75 (sp. 12 mm)

**8014** extendible - ceramic glass / porcelain stoneware top 

(P) L 160/240 P 90 H 75 cm  
 (A) L 180/260 P 90 H 75 cm  
 (G) L 200/300 P 100 H 75 cm  
 (D) L 200/300 P 110 H 75 cm

**8014FRC - 8014FSV**

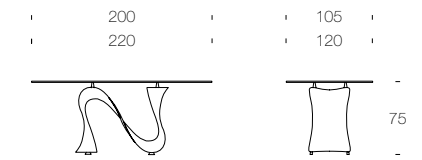

**8014FSM**

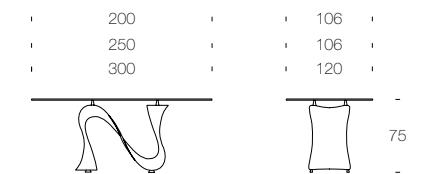

**8014**

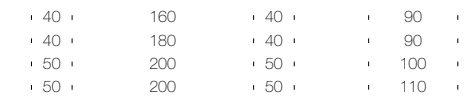

**8014FV** fixed - tempered glass top 

(FP) L 160 P 90 H 75 cm (sp. 12 mm)  
 (FA) L 180 P 90 H 75 cm (sp. 12 mm)  
 (FG) L 200 P 100 H 75 cm (sp. 12 mm)  
 (FD) L 200 P 110 H 75 cm (sp. 12 mm)

**8014FSV** fixed - tempered glass top 

(EL) L 200 P 105 H 75 cm (sp. 12 mm)  
 (ER) L 220 P 110 H 75 cm (sp. 12 mm)

**8014FSL** fixed - tempered glass top - shaped top 

(FP) L 200 P 100 H 75 cm (sp. 20 mm)  
 (FA) L 250 P 120 H 75 cm (sp. 20 mm)  
 (FG) L 300 P 120 H 75 cm (sp. 20 mm)

**8014FV - 8014FRC**

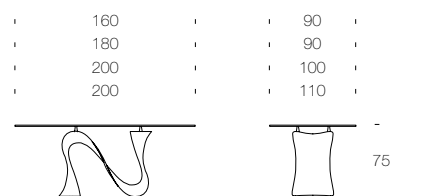

**8014FSV - 8014FSL - 8014FSM - 8014FSC**

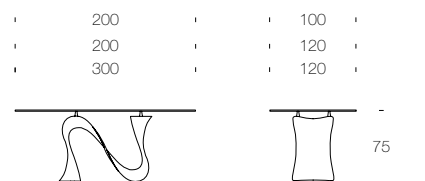

specifiche - specifications

per il campionario completo vedi le pagine finali  
 for the complete samples see the final pages

**6509**

(P) L 100 P 50/200 H 75 cm  
 (A) L 100 P 50/300 H 75 cm

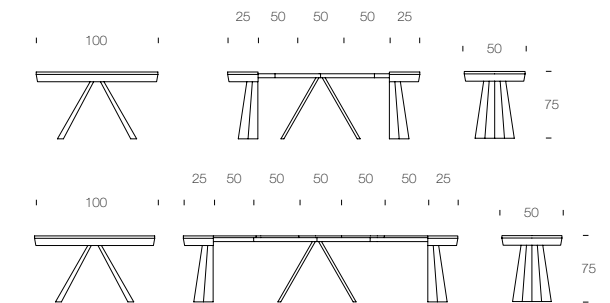

specifiche - specifications

per il campionario completo vedi le pagine finali  
 for the complete samples see the final pages

adria

**8041** L 46 P 55 H 105/47  
**8041A** L 46 P 55 H 105/47

rivestimenti - covering ( S - P - PF - PN - SN ) / struttura - structure ( 72 - 10 )

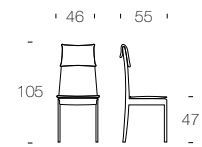

aragona

**7209** L 38 P 55 H 96/48

rivestimenti - covering ( TV - TN - TP - GT - S - P - PF - PN - SN - T\_ \_V ) / struttura - structure ( 14 - 16 - 17 )

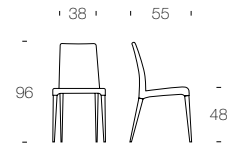

aria easy

**7204** L 50 P 50 H 84/46

seduta - seat ( 85 - 501 ) / struttura - structure ( 01 - 72 - 10 )

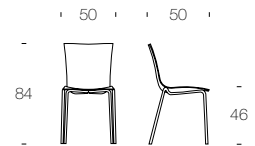

charm

**7216** L 44 P 52 H 97/49

rivestimenti - covering ( S - P - PF - PN - SN )

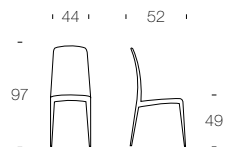

charonne

**7265** L 45 P 52 H 108/48

rivestimenti - covering ( S - P - PF - PN - TV - TN - T\_ \_V - SN ) / struttura - structure ( 72 - 10 )

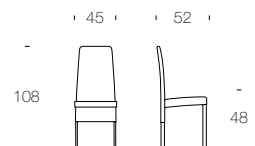

felix

**7280** L 53 P 58 H 78/47

rivestimenti - covering ( S - P - PF - PN - SN ) / struttura - structure ( 14 - 16 - 17 )

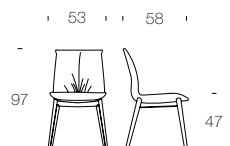

hole

**7207** L 45 P 56 H 86/45

seduta - seat ( 01 - 18 - 51 - 22 - 08 ) / struttura - structure ( 01 - 72 - 10 )

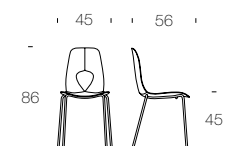

specifiche - specifications

per il campionario completo vedi le pagine finali  
for the complete samples see the final pages

kosmos

**7286** L 48 P 51 H 90/48  
**7286B** L 60 P 51 H 90/48

rivestimenti - covering ( S - P - PF - PN - SN - TV ) / struttura - structure ( 72 - 10 - totalmente rivestita / totally upholstered \*no velluto vega - \*no vega velvet )

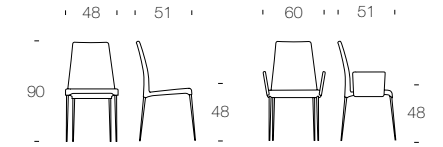

lisetta

**7200** L 51 P 57 H 103/46

rivestimenti - covering ( S - P - PF - PN - SN - TV - TN )

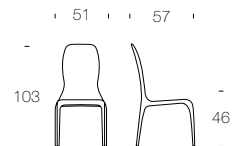

madeleine

**7276** L 43 P 50 H 98/47  
**7268** L 46 P 50 H 98/47  
**7268B** L 65 P 50 H 98/68/47

rivestimenti - covering ( K )

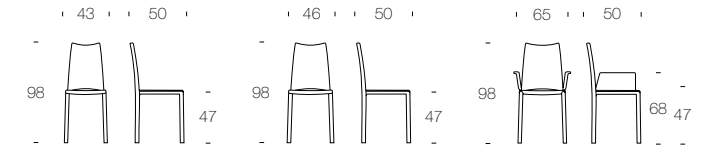

mivida

**7212** L 48 P 55 H 80/46  
**7213** L 65 P 58 H 80/47

rivestimenti - covering ( S - P - PF - PN - SN - T\_ \_V - KT\*solo per 7213 - only for 7213 ) / struttura - structure ( 14 - 16 - 17 )

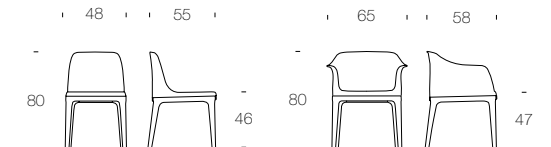

navarra

**7266** L 46 P 57 H 90/46

rivestimenti - covering ( S - P - PF - PN - SN )

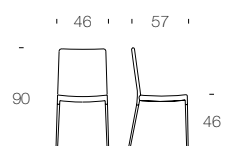

plaza

**7299** L 43 P 50 H 95/47

rivestimenti - covering ( K )

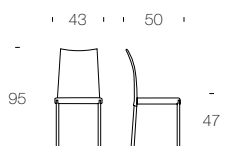

regina

**7201** L 47 P 53 H 81/46

rivestimenti - covering ( S - P - PF - PN - SN )

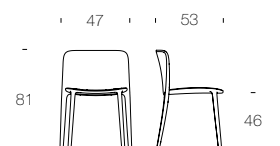

specifiche - specifications

per il campionario completo vedi le pagine finali  
for the complete samples see the final pages

scarlet

7253 L 46 P 57 H 90/46

rivestimenti - covering ( S - P - PF - PN - SN )

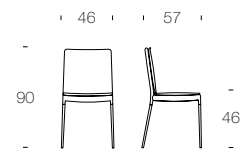

simply

7206 L 54 P 53 H 78/48

rivestimenti - covering ( K ) / struttura - structure ( 72 )

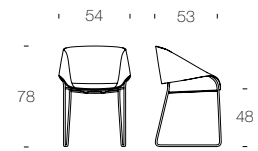

sorbona

7295 L 45 P 52 H 108/48

rivestimenti - covering ( S - P - PF - PN - SN )

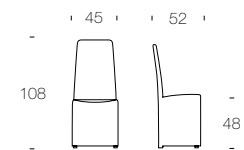

sorrento

8043 L 50 P 65 H 96/47  
8043B L 63 P 65 H 96/63/47

rivestimenti - covering ( S - P - PF - PN - SN - T\_ \_V ) / struttura - structure ( 14 - 16 - 17 )

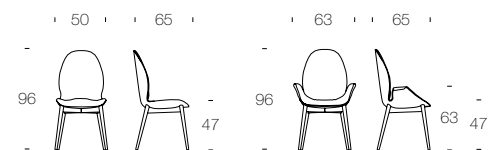

vivienne

7258 L 45 P 52 H 108/48

rivestimenti - covering ( S - P - PF - PN - SN - TV - TN - T\_ \_V ) / struttura - structure ( 72 - 10 )

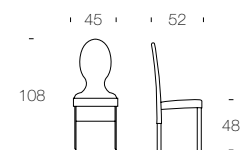

milano (sgabello - stool)

6317 L 37 P 40 H 80/93

rivestimenti - covering ( K )

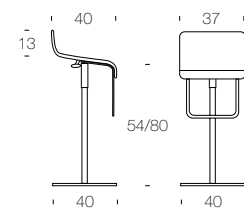

oslo (sgabello - stool)

6319 L 45 P 53 H 85/105

rivestimenti - covering ( 01 - 02 )

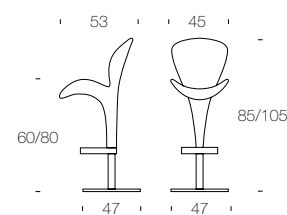

specifiche - specifications

per il campionario completo vedi le pagine finali  
for the complete samples see the final pages

mivida (sgabello - stool)

6318 L 46 P 50 H 99/64  
6318(H1) L 46 P 50 H 107/72

rivestimenti - covering ( S - P - PF - PN - SN - T\_ \_V - KT ) / struttura - structure ( 14 - 16 - 17 )

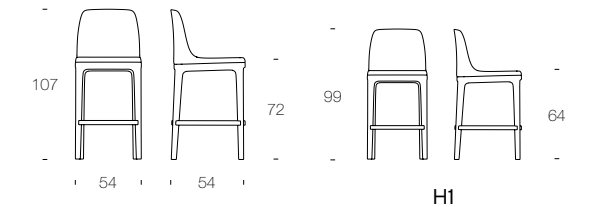

tiffany

7333 L 100 P 82 H 80  
7334 L 190 P 82 H 80

rivestimenti - covering ( S - P - PF - PN - SN ) / struttura - structure ( 14 - 16 - 17 )

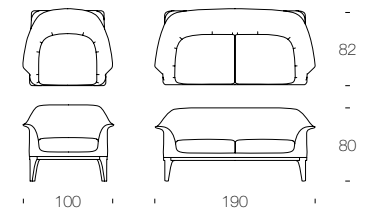

ricciolo

7865 L 65 P 95/145 H 32/45/90

rivestimenti - covering ( S - TO - P - PF - T\_ \_V - SN )

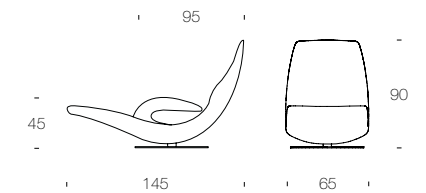

nolita

AT111R L 70 P 85 H 42/118

rivestimenti - covering ( S - P - PF - SN - PN - T\_ \_V )

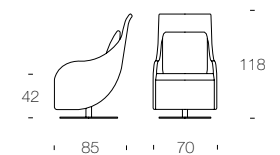

portofino

7218 L 43 P 57 H 95/47

rivestimenti - covering ( S - P - PF - PN - SN ) / struttura - structure ( 14 - 16 - 17 )

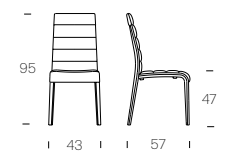

specifiche - specifications

per il campionario completo vedi le pagine finali  
for the complete samples see the final pages



finiture | finishing

strutture | structures

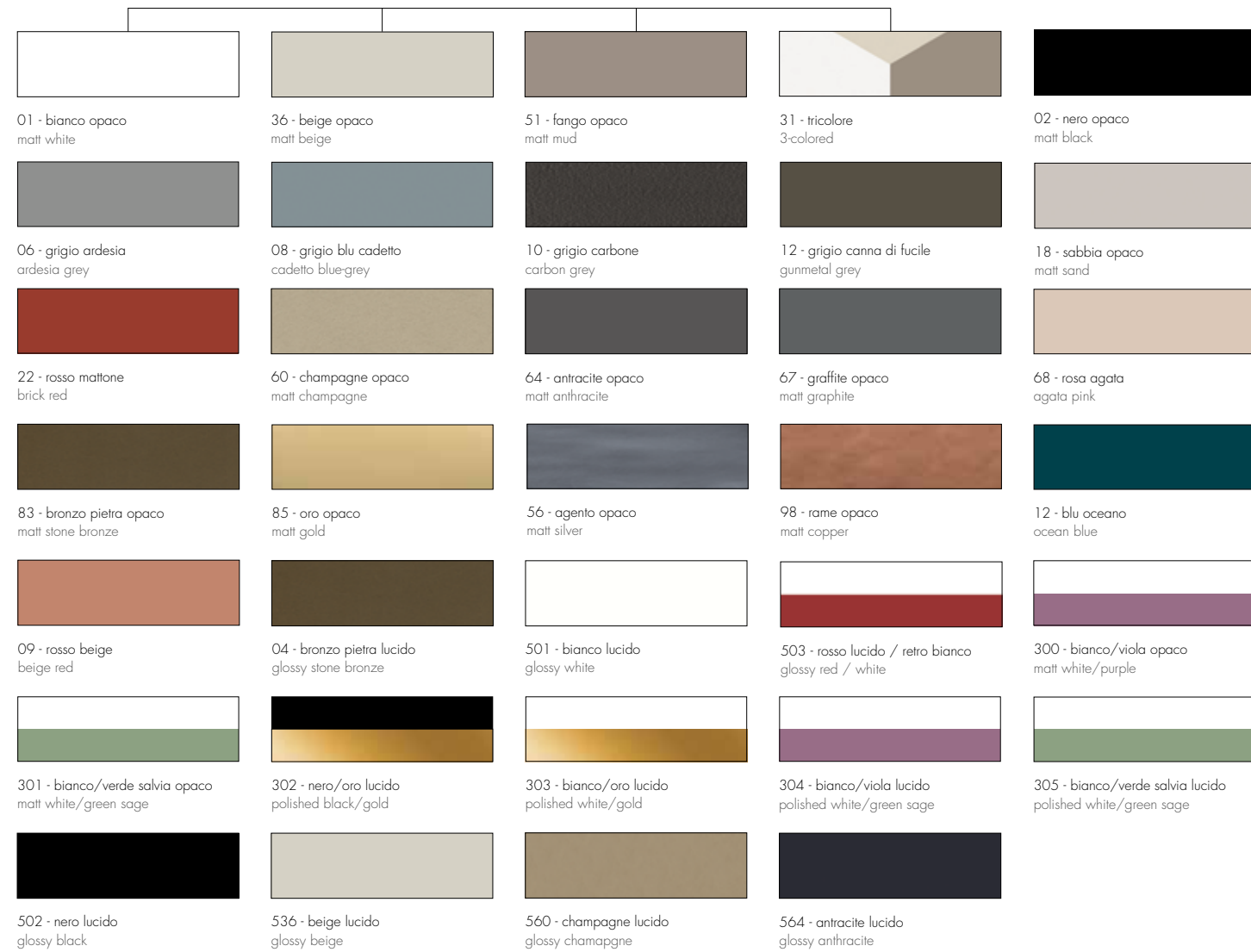

essenze | essences



finiture | finishing

laminato - L | laminated - L



melaminico - L | melaminic - L



marmi - M | marbles - M



vetro ceramicato - V\_\_C | ceramic glass - V\_\_C



gres porcellanato - V\_\_P | porcelain stoneware - V\_\_P



## finiture | finishing

### vetri - V | glasses - V



V\_2 - vetro nero  
black glass



V\_84 - vetro trasparente bronze  
transparent bronze glass



V\_101 - vetro extra chiaro bianco  
extra-clear white glass



V\_160 - vetro extra chiaro champagne  
extra-clear champagne glass



V\_636 - vetro extra chiaro acidato beige  
extra-clear acid-etched beige glass



V\_664 - vetro extra chiaro acidato antracite  
extra-clear acid-etched anthracite glass



V\_601 - vetro extra chiaro acidato bianco  
extra-clear acid-etched white glass



V\_602 - vetro acidato nero  
acid-etched black glass



V\_81 - vetro trasparente  
transparent glass



V\_100 - vetro extra chiaro trasparente  
extra-clear transparent glass



V\_85 - vetro fumé trasparente  
transparent fumé glass

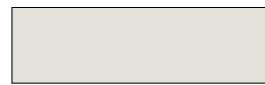

V\_136 - vetro extra chiaro beige  
extra-clear beige glass



VS\_85 - vetro fumé satinato  
frosted fumé glass



VS\_85 - vetro grey satinato  
frosted grey glass

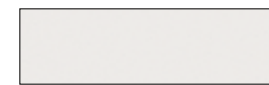

VS\_10 - vetro extra chiaro satinato  
frosted extra-clear glass



V\_84A - vetro trasparente bronze serigrafato  
transparent bronze glass with serigraphy



V\_84B - vetro acidato bronze serigrafato  
frosted bronze glass with serigraphy

### specchi - V | mirrors - V



V\_45 - specchio argentato  
silver mirror



V\_184 - specchio bronze  
bronzed mirror



SP\_29 - specchio grigio  
grey mirror



SP\_85 - specchio oro  
gold mirror

### tecnoril | tecnoril



01 - bianco opaco  
matt white

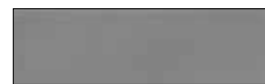

05 - grigio opaco  
matt grey

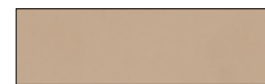

43 - roux opaco  
matt roux

### polietilene | polyethylene



01 - bianco  
white



03 - rosso  
red



15 - verde  
green



36 - beige  
beige



64 - antracite  
anthracite



66 - fucsia  
fuchsia



54 - bronzo effetto corten  
bronze corten effect



60 - tortora  
dove grey



07 - azzurro pastello  
pastel light blue



48 - bianco opalino  
opaline white

## finiture | finishing

### metalli | metals



01 - alluminio verniciato bianco opaco  
aluminum lacquered matt white



32 - alluminio anodizzato  
anodized aluminum



71 - alluminio brillantato  
polished aluminum

### cromo | chrome



72 - metallo cromato  
chromed metal



75 - cromo ramato  
coppered chrome

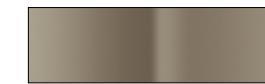

76 - cromo nero  
black chrome

### plexiglass - X | plexiglass - X



X\_81 - plexiglass trasparente  
transparent



X\_22 - plexiglass rosso rubino  
ruby red



X\_85 - plexiglass grigio fumé  
trasparente  
transparent grey fumé



X\_02 - nero  
black



X\_62 - bianco opalino  
opaline white

tessuti e pelli | fabrics and leathers

tessuto ninfea - TN | ninfea fabric - TN



TN\_04 - giallo cedro  
cedar yellow



TN\_08 - mandorla  
almond



TN\_16 - blu jeans  
jeans blue



TN\_17 - verde polinesia  
polynesia green



TN\_22 - tabacco  
tobacco



TN\_29 - grigio gabbiano  
gull grey



TN\_51 - fango  
mud



TN\_65 - roccia  
rock

tessuto orchidea - TO | orchidea fabric - TO



TO\_01 - bianco  
white



TO\_02 - nero  
black



TO\_40 - blu turchese  
turquoise blue



TO\_41 - rosso ciclamino  
cyclamen red



TO\_51 - fango  
mud



TO\_64 - grigio antracite  
anthracite grey



TO\_70 - testa di moro  
dark brown

tessuto pied de poule - TP | pied de poule fabric - TP



TP\_04 - giallo  
yellow



TP\_03 - rosso mattone  
brick red



TP\_64 - grigio  
grey



TP\_60 - tortora  
dove grey

tessuto gessato - GT | gessato fabric - GT



GT\_04 - giallo  
yellow



GT\_03 - rosso mattone  
brick red



GT\_64 - grigio  
grey



GT\_60 - tortora  
dove grey

tessuti e pelli | fabrics and leathers

tessuto mimosa - TK | mimosa fabric - TK



TK\_03 - rosso rubino  
ruby red



TK\_04 - giallo  
yellow



TK\_17 - verde brillante  
bright green



TK\_34 - blu ottanio  
oil blue



TK\_36 - beige  
beige



TK\_60 - tortora  
dove grey

tessuto verbena - TV | verbena fabric - TV



TV\_01 - bianco  
white



TV\_02 - nero  
black



TV\_03 - rosso  
red



TV\_04 - giallo  
yellow



TV\_51 - fango  
mud



TV\_64 - grigio antracite  
anthracite grey



TV\_70 - testa di moro  
dark brown



TV\_91 - sabbia  
sand

pelle nabuk - PN | nabuk leather - PN



PN\_2 - nero  
black



PN\_5 - panna  
cream



PN\_9 - rosso bordeaux  
burgundy red



PN\_51 - fango  
mud



PN\_70 - testa di moro  
dark brown



PN\_73 - grigio  
grey



PN\_100 - ecrù  
ecru

tessuti e pelli | fabrics and leathers

ecopelle - S | eco leather - S



cuoio - K | thick leather - K



tessuti e pelli | fabrics and leathers

pelle - P | leather - P

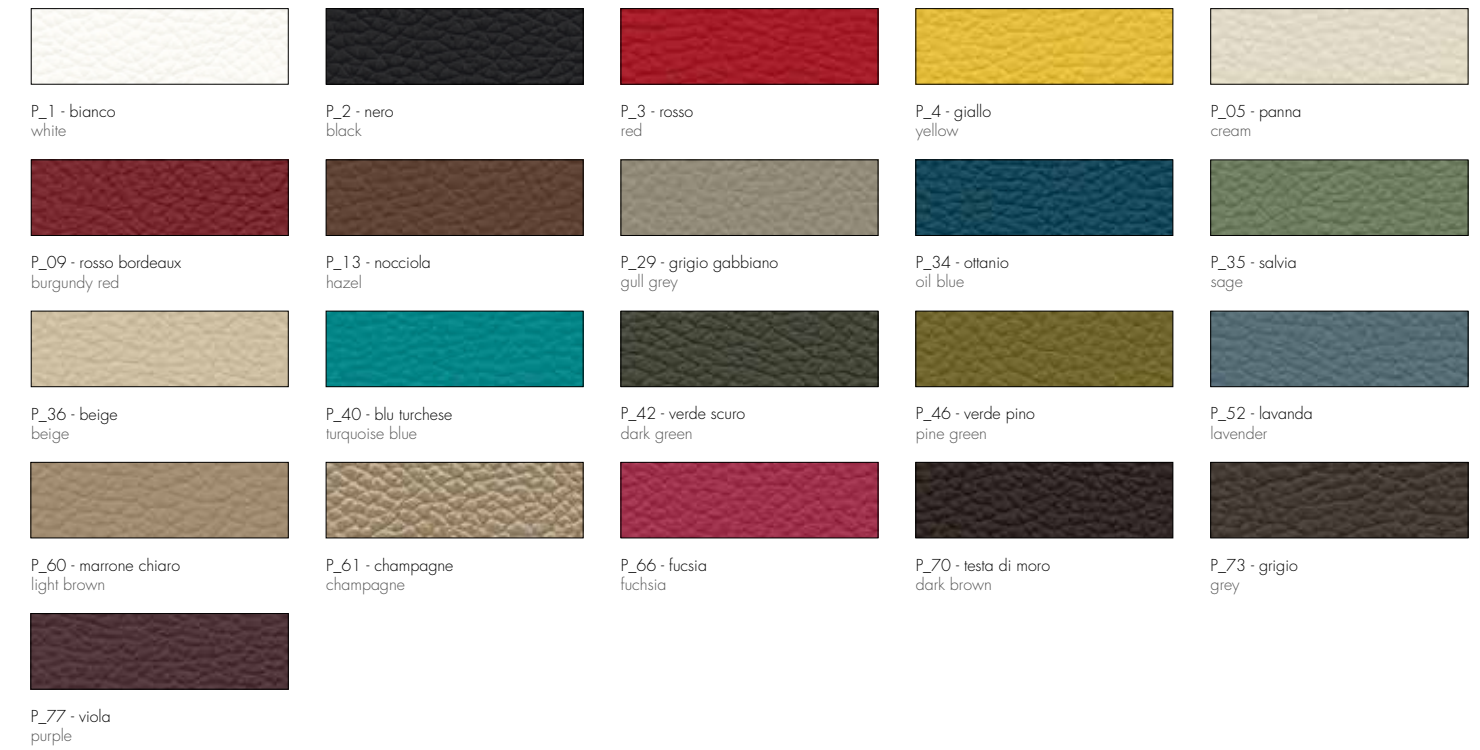

pelle fiore - PF | grain leather - PF





tessuti e pelli | fabrics and leathers

velluto vega - T\_ \_V | vega velvet - T\_ \_V

---



T02V - nero  
black



T03V - grigio marrone  
grey-brown



T04V - grigio camel  
camel grey



T05V - rosso ruggine  
rusty red



T06V - bordeaux antico  
old burgundy red



T07V - ottanio  
oil blue



T08V - verde menta  
mini green



T09V - glicine  
wisteria



T10V - blu profondo  
deep blue



T11V - seta  
silk



T12V - grigio caldo  
warm grey

cucitura a contrasto | contrast-stitching

---



0446 - blu universo  
universe blue



0410 - arancio riflesso  
reflected orange



0001 - bianco  
white



0002 - nero  
black

ecopelle nabuk - SN | nabuk eco-leather - SN

---



SN\_01 - panna  
cream



SN\_03 - ecrù  
ecrù



SN\_04 - nocciola  
hazel



SN\_05 - testa di mora  
dark brown



SN\_06 - grigio  
grey



SN\_10 - ottanio  
oil blue



SN\_13 - grigio seta  
silk grey



SN\_16 - rosso bordeaux  
burgundy red

Fondata da Gianni Tonin più di 40 anni fa, TONIN CASA è stata sin dall'inizio esempio di passione, eleganza e ricerca nel settore arredamento.

Nel 1975 la sua attività principale era il commercio di scarpiera e mobili classici, pubblicando il primo catalogo nel 1982.

Il successo e la fiducia dei clienti fecero sì che nei primi anni '90 venisse avviata la produzione di mobili moderni, accompagnati dall'edizione di cataloghi dedicati ed all'espansione dell'area commerciale oltre il Triveneto.

Tonin casa, da allora, è in costante sviluppo e crescita, impegnata nel commercio a livello mondiale e nell'esportazione dei valori del Made in Italy, con prodotti sintesi di bellezza e funzionalità. Segni e tendenze che promuovono la tradizione del Design Italiano nel mondo.

Founded by Gianni Tonin more than 40 years ago, TONIN CASA has been, since the very beginning, a perfect example of passion, elegance and research in the furniture business.

In 1975 its main activity was the production of shoe cabinets and classical furniture, publishing the first catalogue in 1982.

Due to its success and the trust from our clientele, at the beginning of the Nineties, we started our production of modern furniture, together with publishing of specific dedicated catalogues and the expansion to areas beyond Northern Italy.

Since then, TONIN CASA has been in a continuous development and growth, engaging into worldwide sales and exporting the values of Made in Italy, with products which resume beauty and functionality. Signs and trends that promote the tradition of Italian Design in the world.

Основанная Джанни Тонин более чем 40 лет назад, фабрика Tonin Casa была с самого начала примером страсти, элегантности и исследований в мебельной индустрии.

В 1975 году основным направлением его деятельности было торговля шкафчики для обуви и классической мебелью, издававши первый каталог в 1982 году.

Успех и доверие клиентов означало, что в начале 90-х было запущено производство современной мебели, сопровождаемое изданием каталогов, посвященных расширению торговой площади за пределами Тривенето.

Tonin Casa, с тех пор, находится в постоянном развитии и росте, занимается торговлей по всему миру и экспортное значения "Сделано в Италии", с продуктами синтеза красоты и функциональности. Признаки и тенденции, которые способствуют традиции итальянского дизайна в мире.

**Stampa:**

Grafiche Antiga

**Stampato in Italia Marzo 2017**

La ditta "Tonin Casa divisione della Progetto Design International s.r.l." si riserva la facoltà di modificare in qualunque momento e senza preavviso, le caratteristiche tecniche degli elementi usati nel presente catalogo.

Alcuni accessori presenti nelle immagini fotografiche non sono prodotti dalla ditta "Tonin Casa divisione della Progetto Design International s.r.l." Si prega di far riferimento al listino prezzi.

La ditta "Tonin Casa divisione della Progetto Design International s.r.l." si riserva inoltre il diritto di apportare ai propri prodotti quelle modifiche che si riterranno necessarie o utili al fine di migliorarli senza pregiudicarne le caratteristiche essenziali.

È vietata ogni riproduzione totale e parziale in Italia e all'estero.

"Tonin Casa divisione della Progetto Design International s.r.l." reserves the right to modify the technical characteristics of the elements shown in this catalogue, at any time and without notice.

Some of the accessories shown in the photos are not produced by "Tonin Casa divisione della Progetto Design International s.r.l.". Please refer to price-list.

"Tonin Casa divisione della Progetto Design International s.r.l." also reserves the right to make any modifications to its products, deemed necessary or useful in order to improve them without impairing their basic characteristics.

Total or partial reproduction of the products is prohibited in Italy and abroad.

Компания "Tonin Casa divisione della Progetto Design International s.r.l." оставляет за собой право изменять в любое время и без предварительного уведомления, технические характеристики элементов, используемых в этом каталоге.

Некоторые аксессуары, представленные на фотографиях, не производятся фирмой "Tonin Casa divisione della Progetto Design International s.r.l." Пожалуйста, обратитесь к прайс-листу.

Компания "Tonin Casa divisione della Progetto Design International s.r.l." также оставляет за собой право вносить в наши собственные продукты те изменения, которые вы считаете необходимым или полезным для того, чтобы улучшить их без ущерба для их основные характеристики.

Запрещается полное или предвзятое воспроизводство в Италии и за рубежом.

progetto  
design

**Tonin**  
CASA

**Tonin Casa**  
divisione della  
Progetto Design International srl

via Palladio, 43  
35010, San Giorgio in Bosco (PD), Italy

t +39 049 9453300  
f +39 049 9450725

info@tonincasa.it  
c.f. P.iva IT03817150240

versione 0.1

